

(PL) Instrukcja montażu

(GB) Assembly instructions

(DE) Montageanleitung

(FR) Notice de montage

(IT) Istruzioni di montaggio

(NL) Montage-instructies

RIVA 814

UWAGA /REMARQUE/ /NOTE/ ATATTENZIONE /HINWEIS /LETOP

(PL) Maksymalna wysokość słupa wody ~ 1.2 m

(FR) Niveau maximum de la colonne d'eau ~ 1.2 m

(GB) The maximum water column level ~ 1.2 m

(IT) Livello massimo della colonna d'acqua ~ 1.2 m

(DE) Maximaler Wasserstand ~ 1.2 m

(NL) Maximum niveau waterkolom ~ 1.2 m

Objętość wody w basenie 34.21 m³

Le volume de l'eau dans la piscine 34.21 m³

Water capacity in the pool 34.21 m³

Il volume di acqua in piscina 34.21 m³

Volumen von Wasser im Schwimmbecken 34.21 m³

Water inhoud van het zwembad 34.21 m³

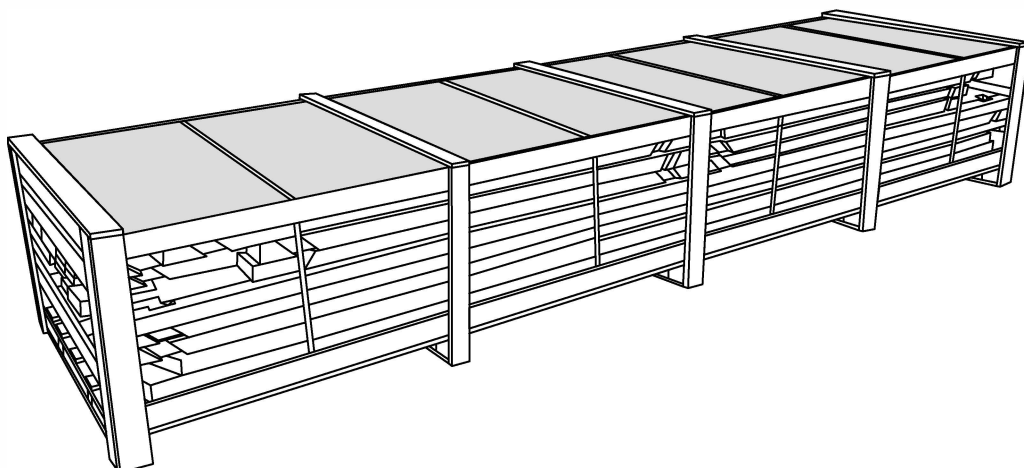
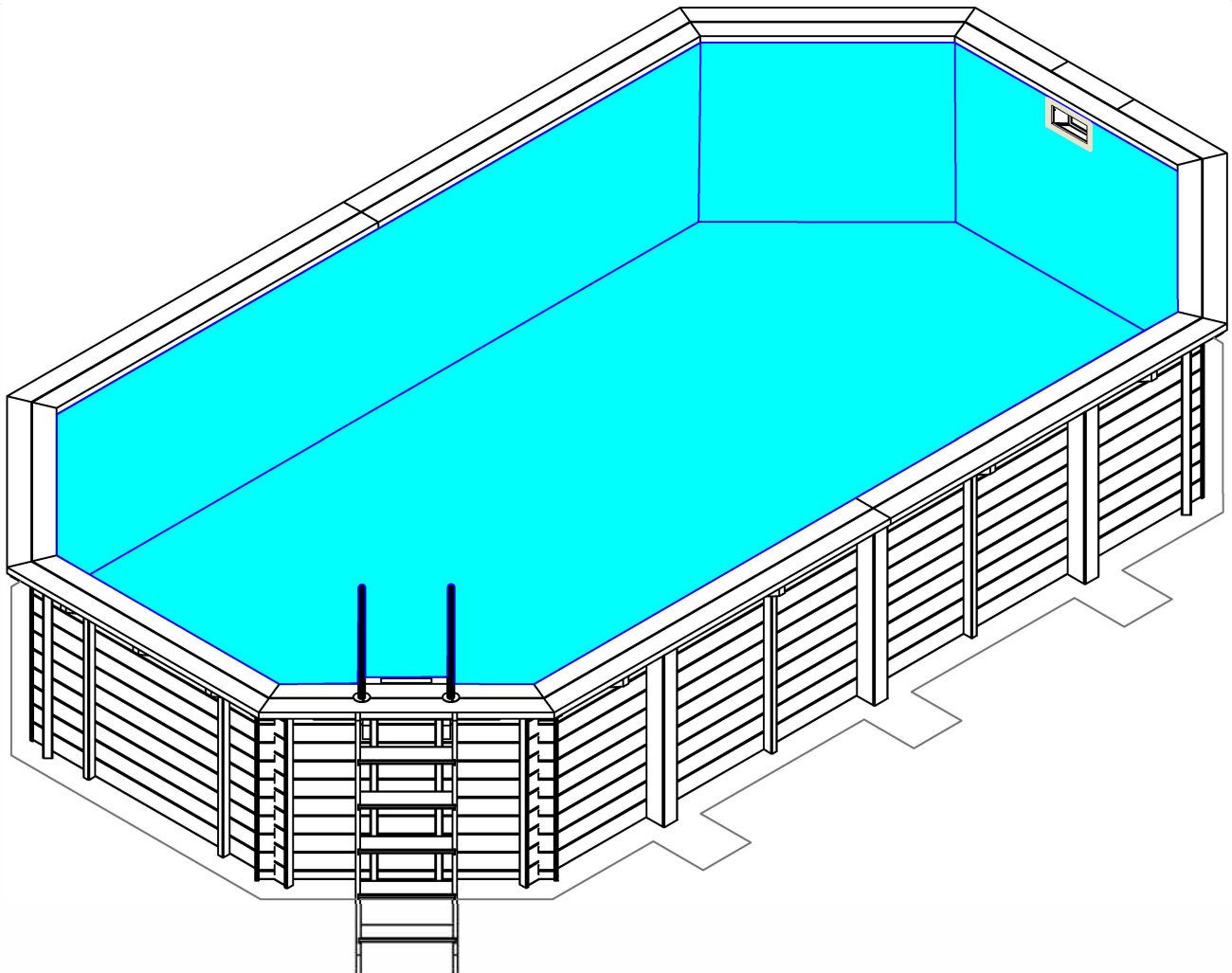

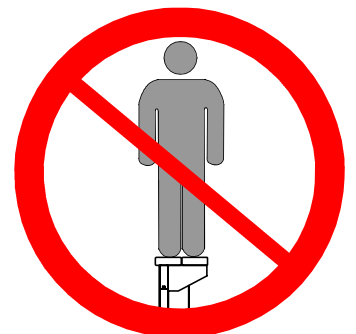
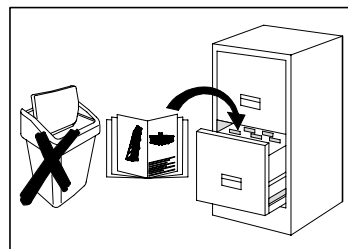
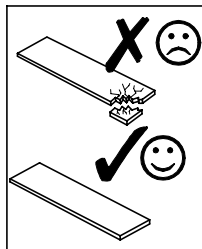
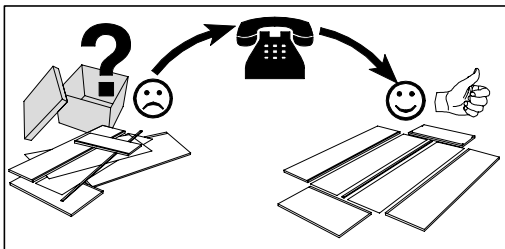
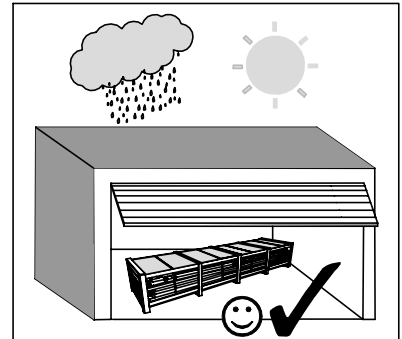
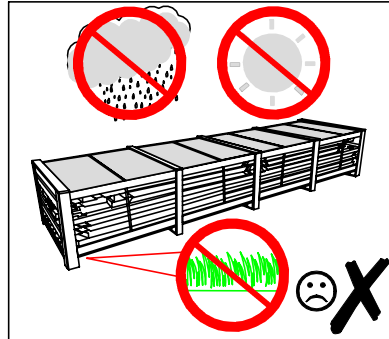
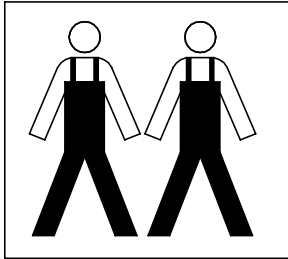
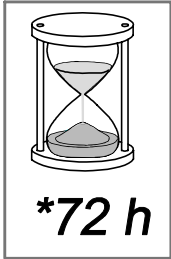

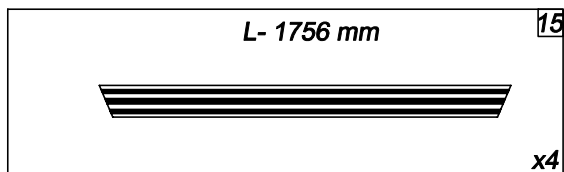
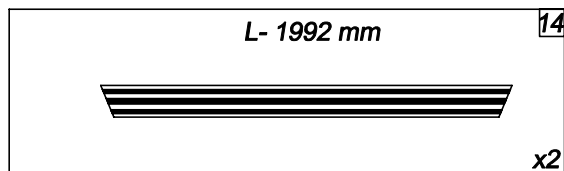
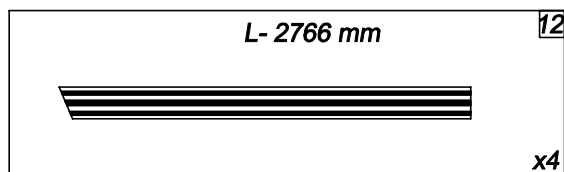
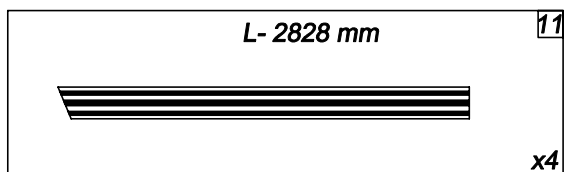
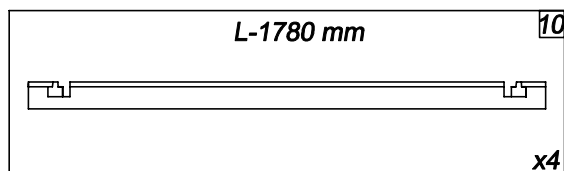
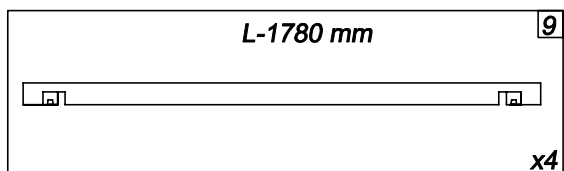
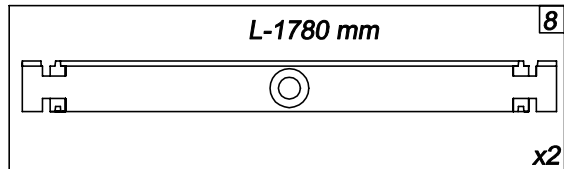
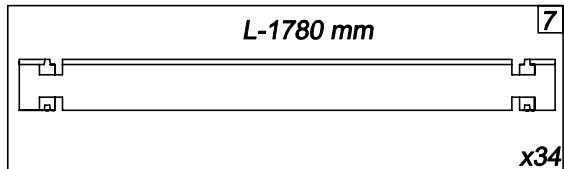
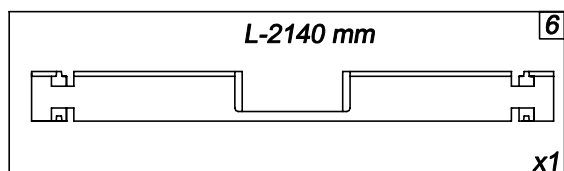
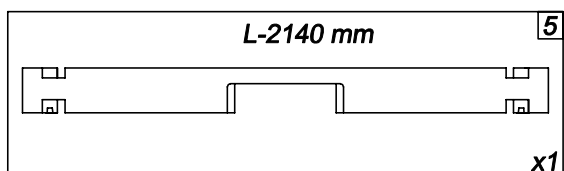
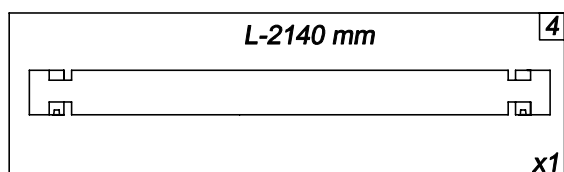
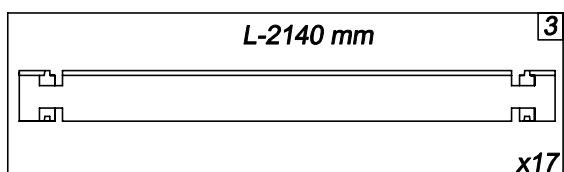
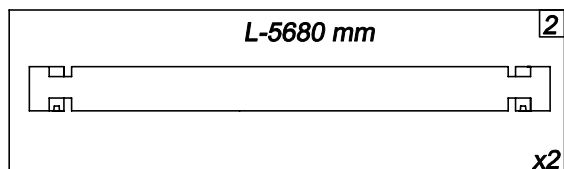
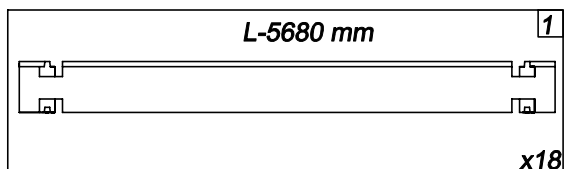
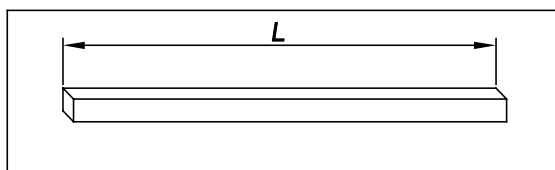

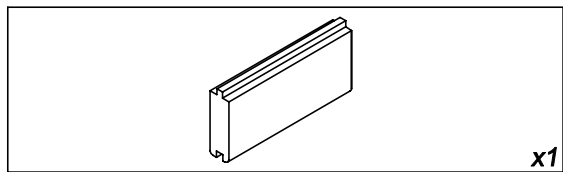
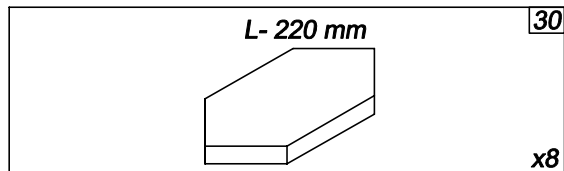
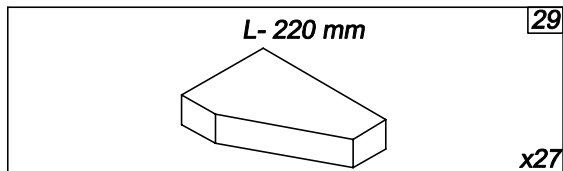
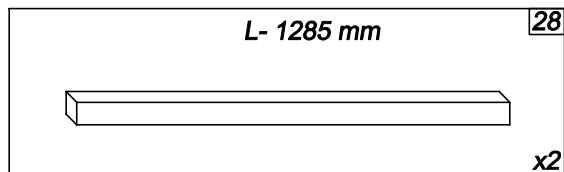
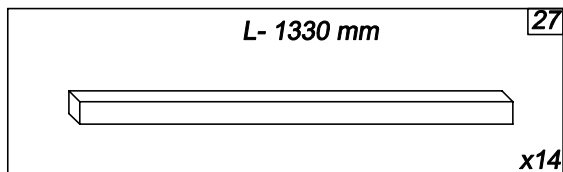
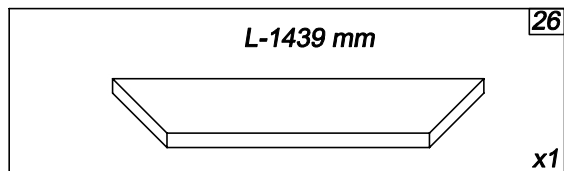
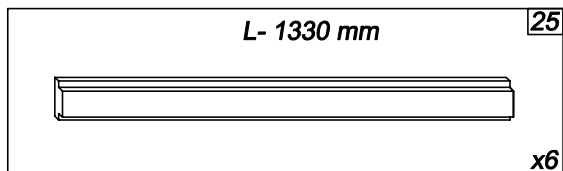
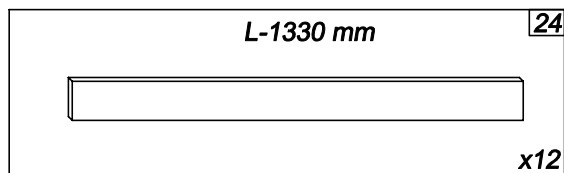
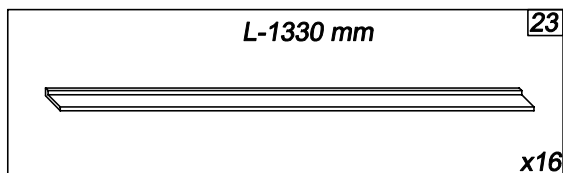
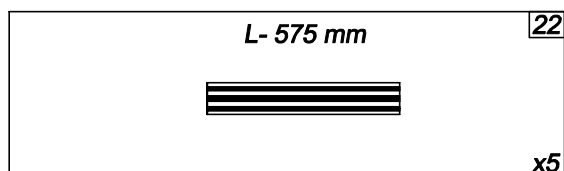
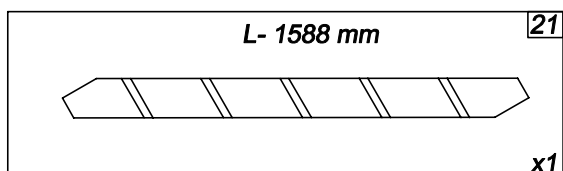
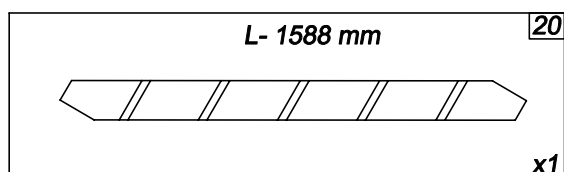
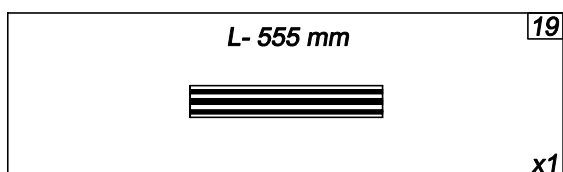
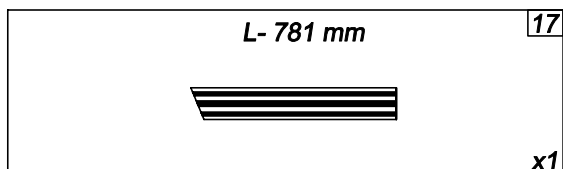
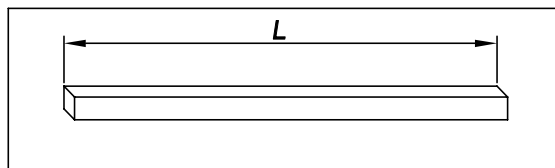

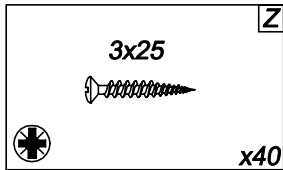
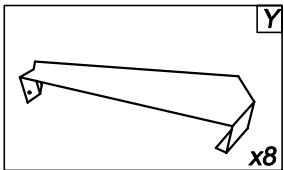
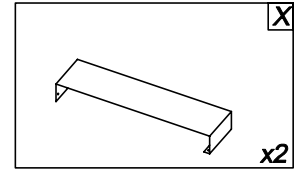
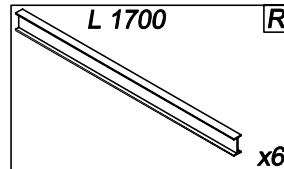
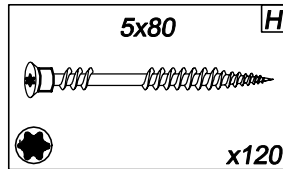
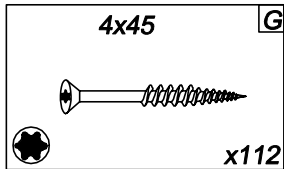
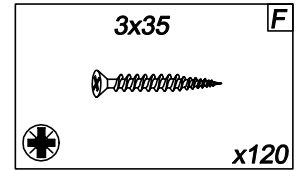
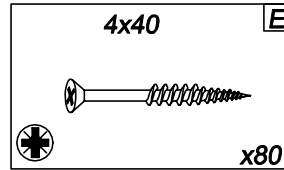
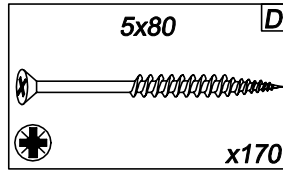
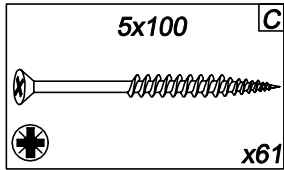
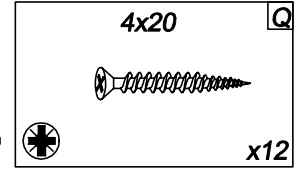
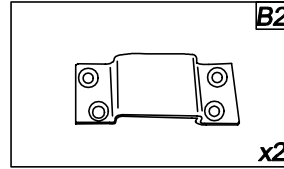
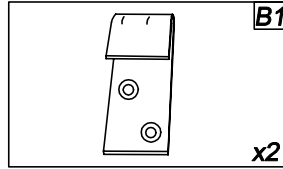
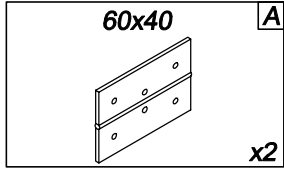

PL Podłoże

GB Ground

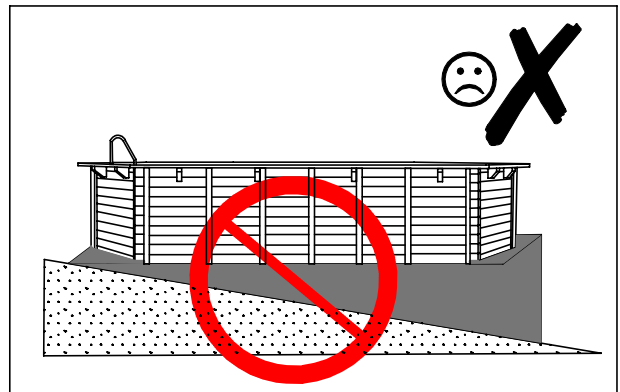
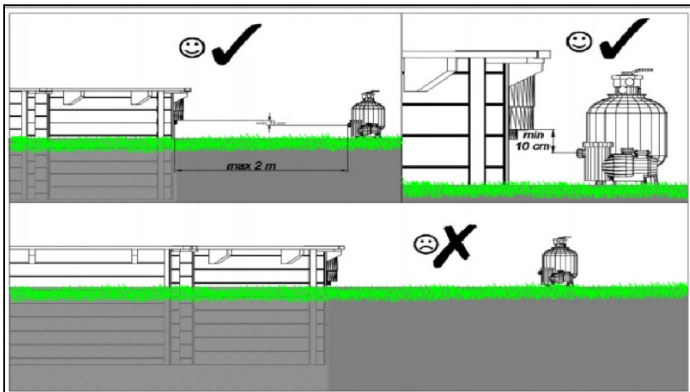
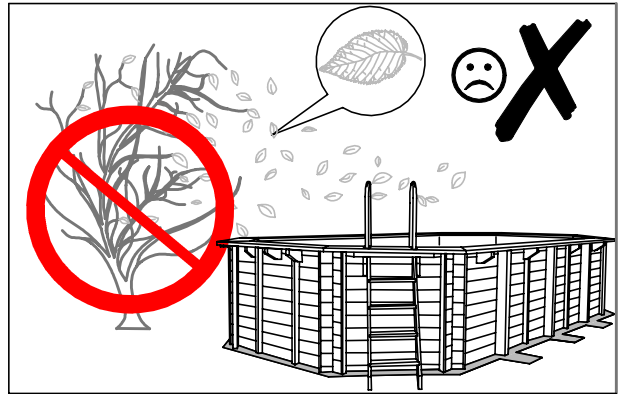
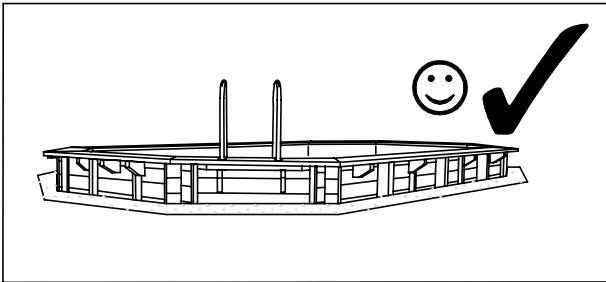
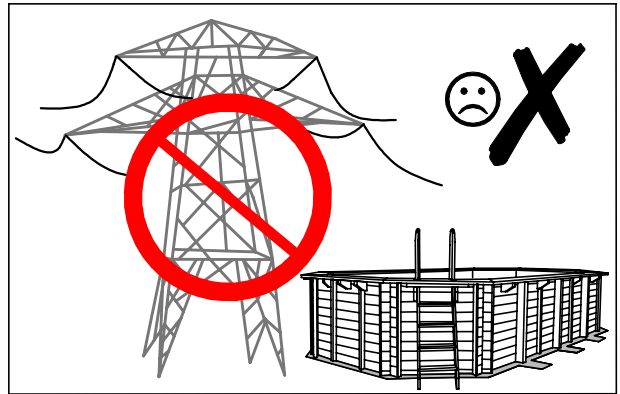
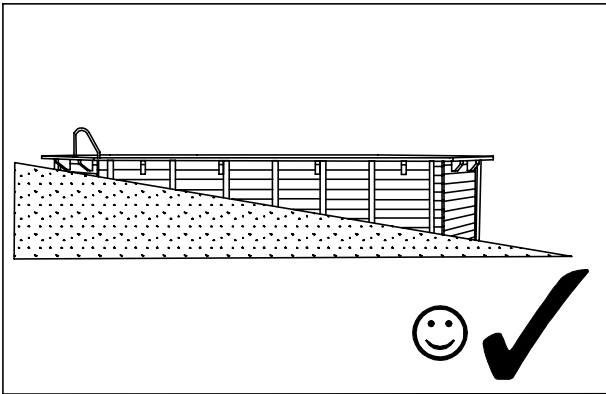
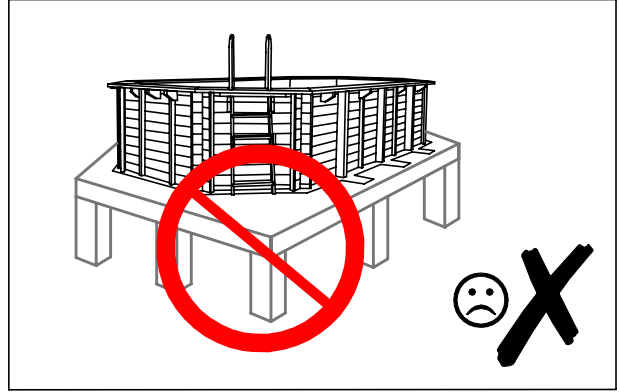
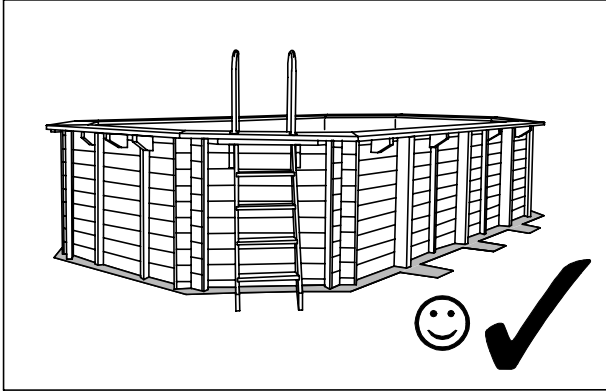



- 1** FUNDAMENT BASENU / FUNDATION
- 2** RURA DRENARSKA / DRAINAGE PIPE
- 3** PĘCHERZYKOWA FOLIA FUNDAMENTOWA / FOUNDATION BUBBLE WRAP
- 4** ŻWIR / GRAVEL
- 5** GEOWŁÓKNINA OGRODOWA / GEOTEXTILE
- 6** GRUNT / GROUND

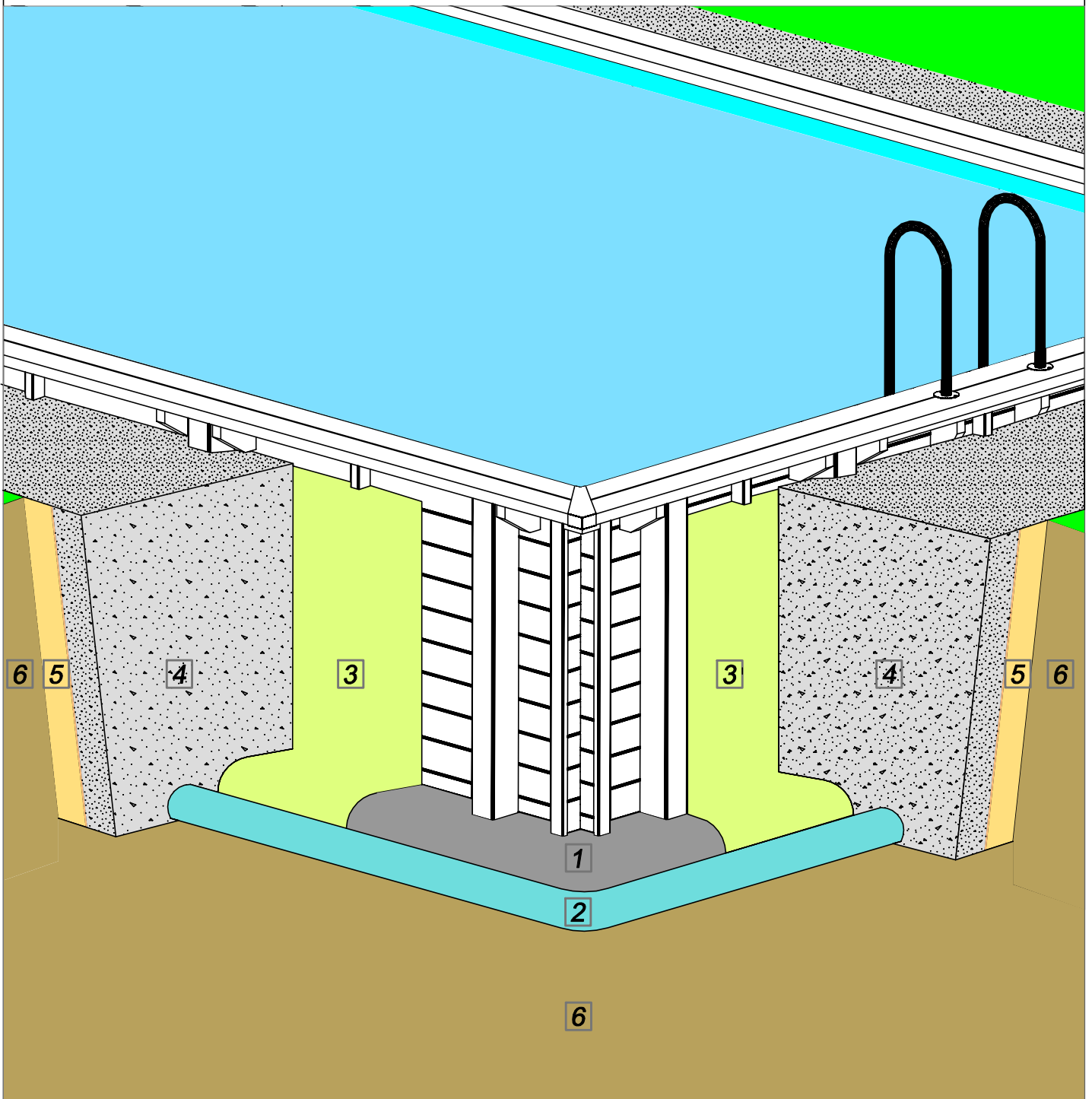

PL Podłoże

GB Ground



N.B. Soluzione non applicabile a un sistema autoportante. (Vedere pag. 38-39)

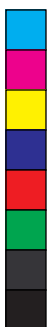
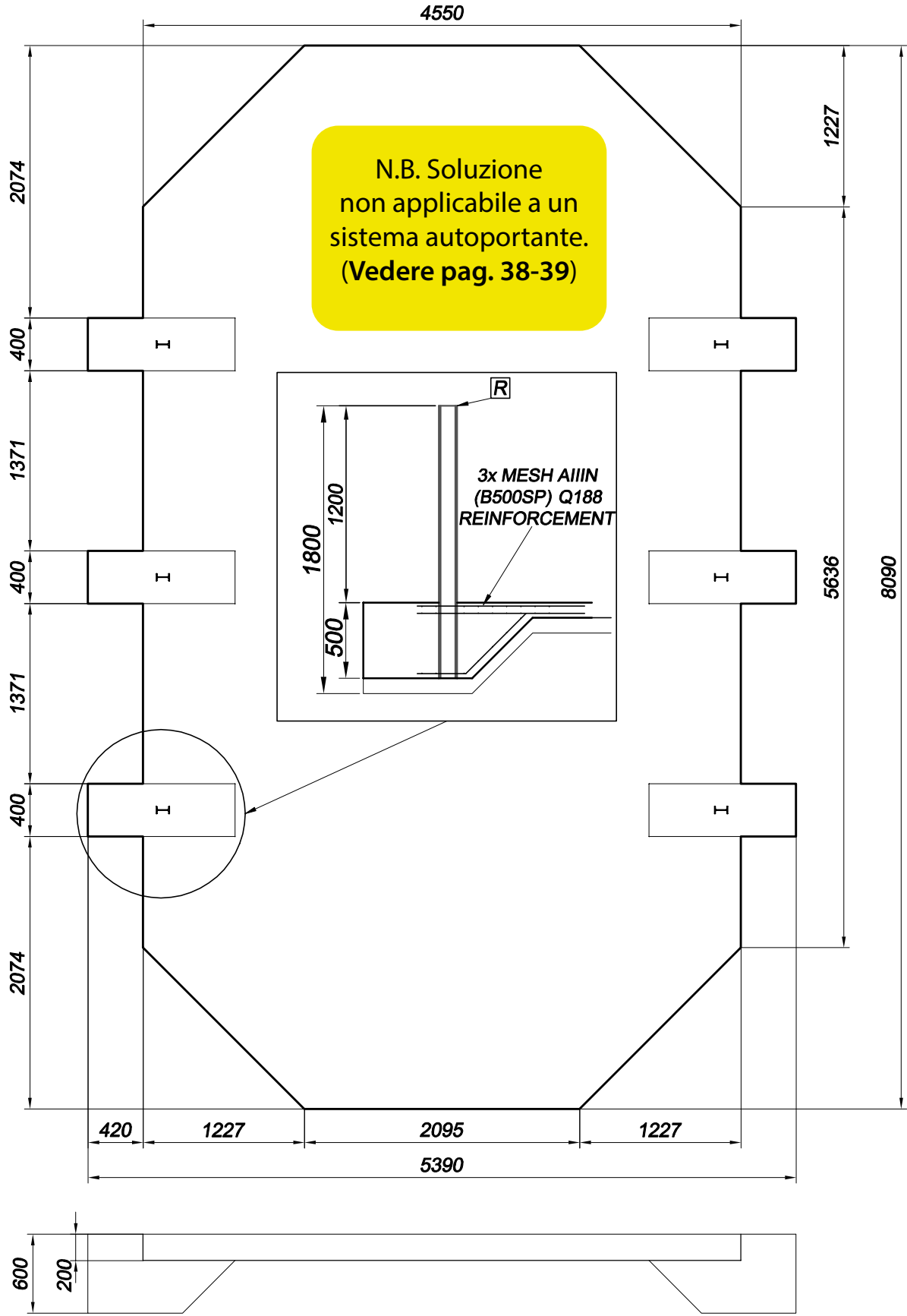
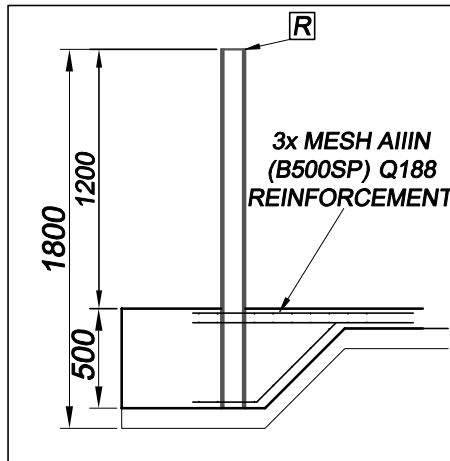

PL Podłoże

GB Ground



N.B. Soluzione non applicabile a un sistema autoportante. (Vedere pag. 38-39)

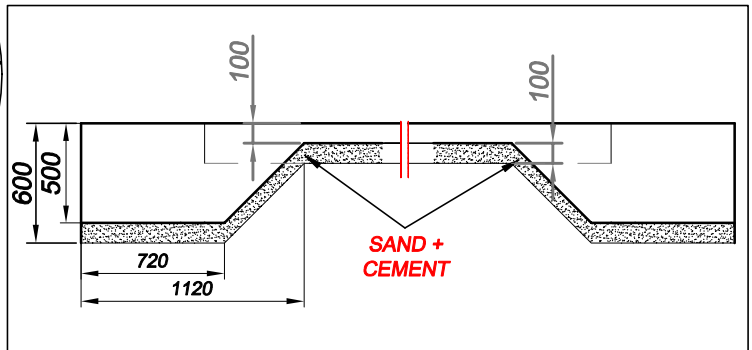
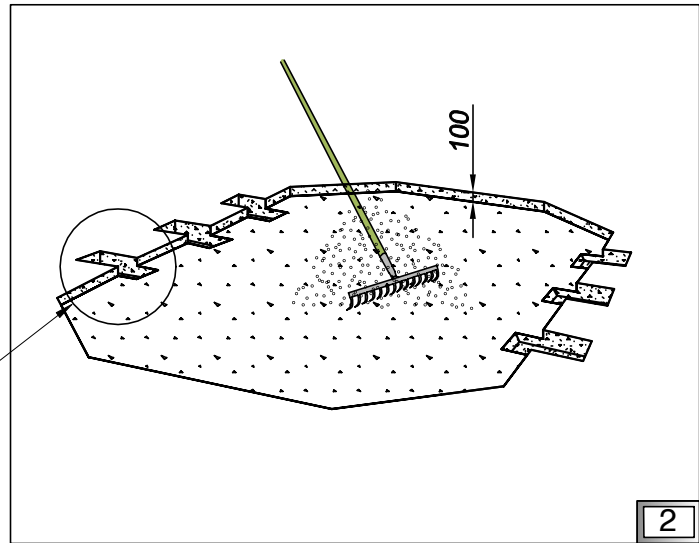
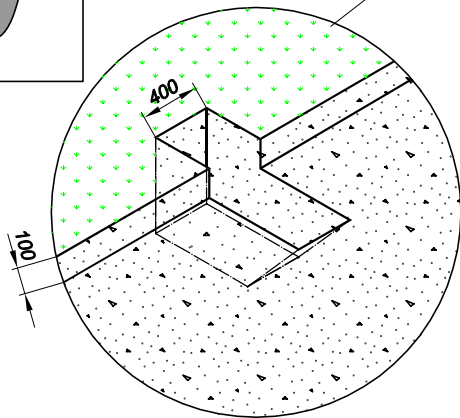
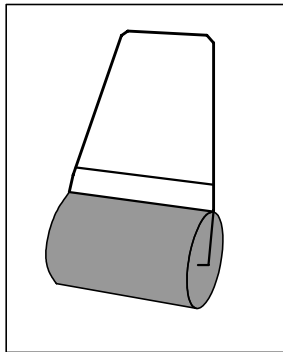
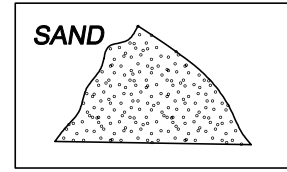
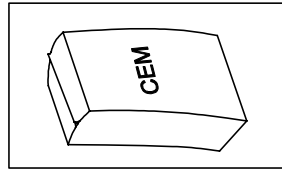
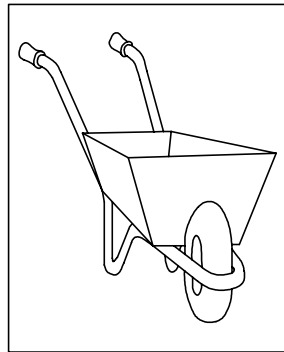
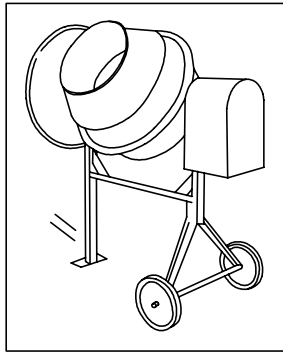
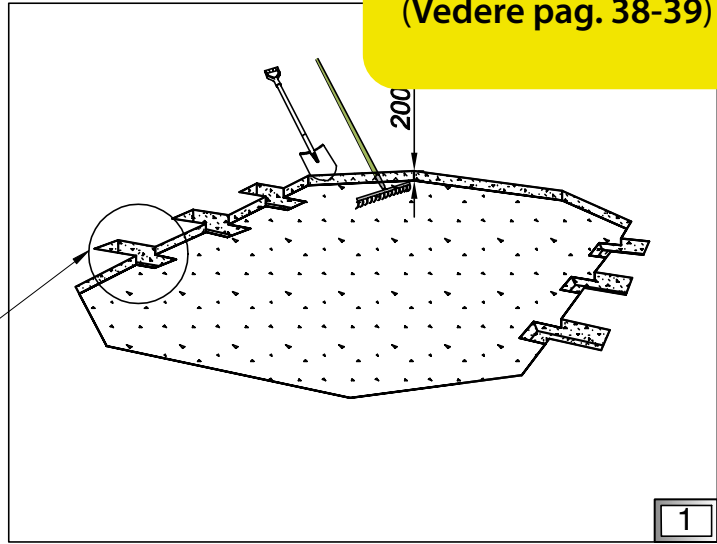
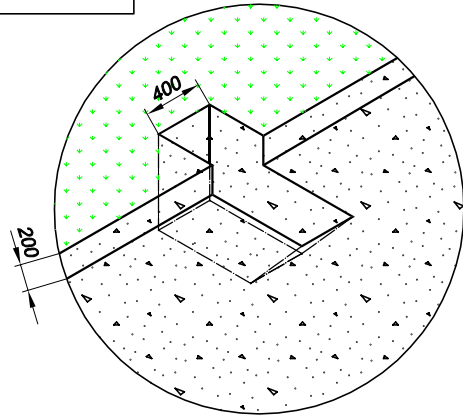
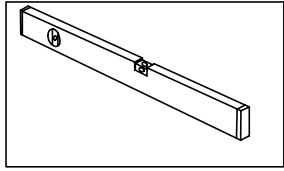

PL Podłoże

GB Ground



N.B. Soluzione non applicabile a un sistema autoportante. (Vedere pag. 38-39)

2T "R"

3x MESH AIIIN (B500SP) Q188 REINFORCEMENT

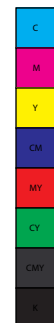
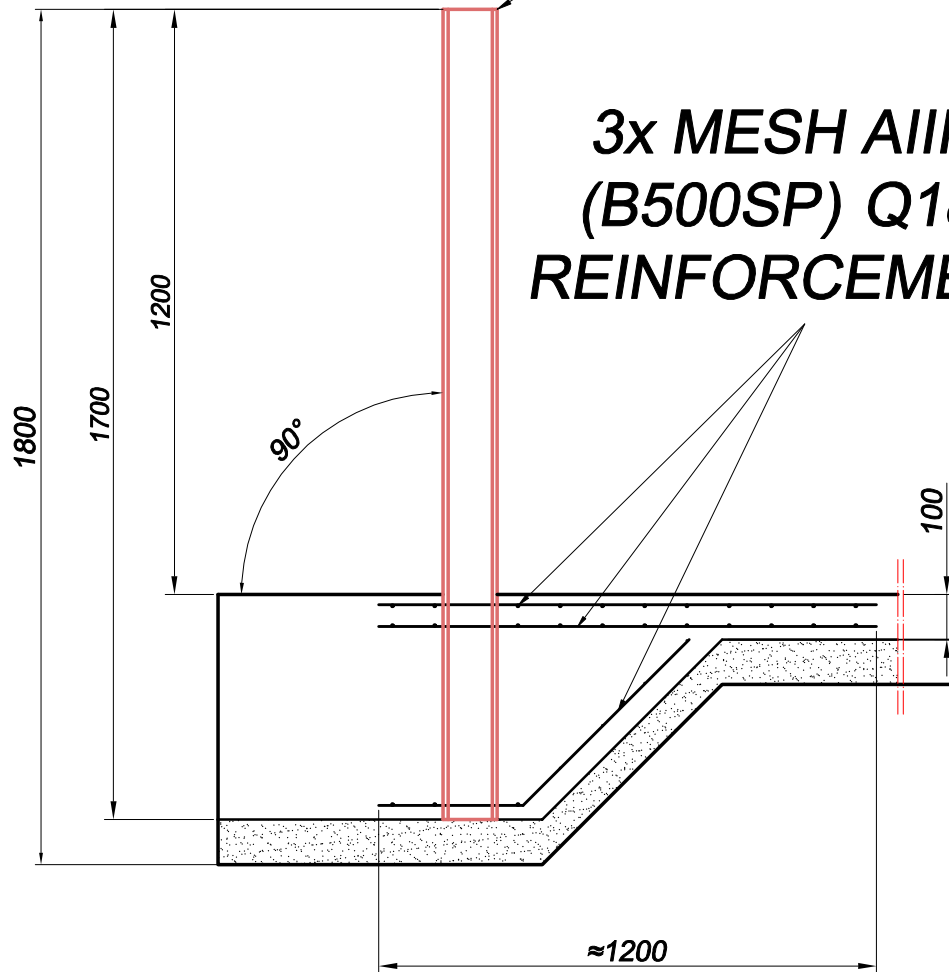

PL Podloze

GB Ground



N.B. Soluzione non applicabile a un sistema autoportante. (Vedere pag. 38-39)

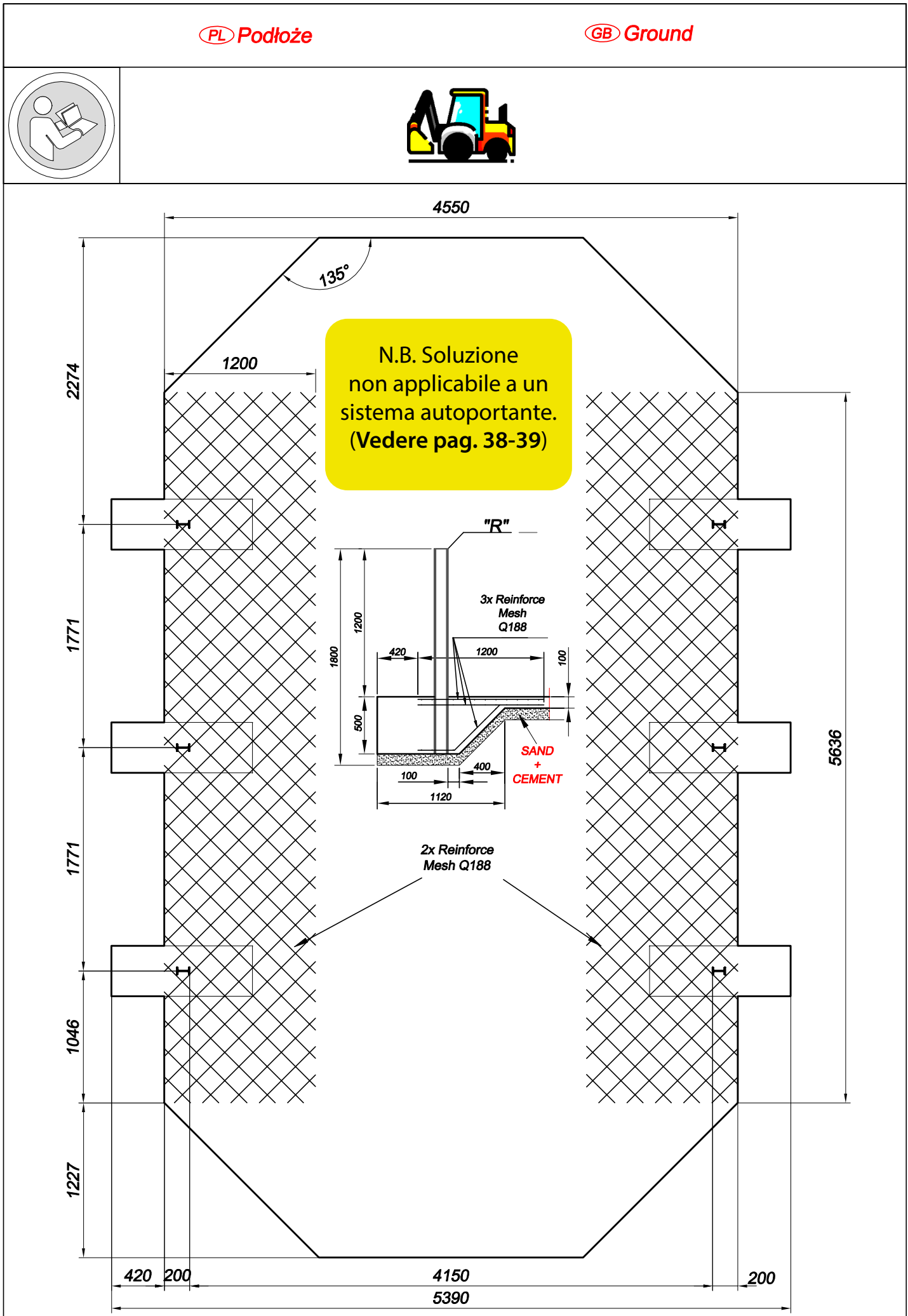

PL Podłoże

GB Ground

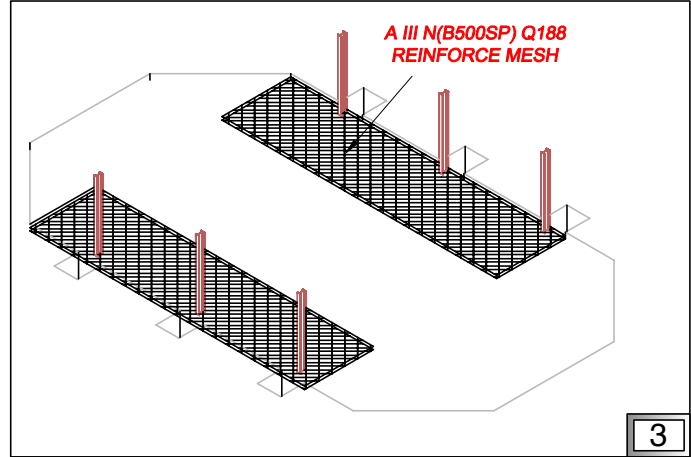
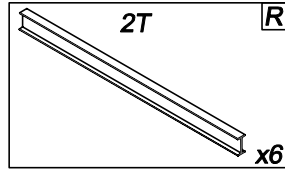
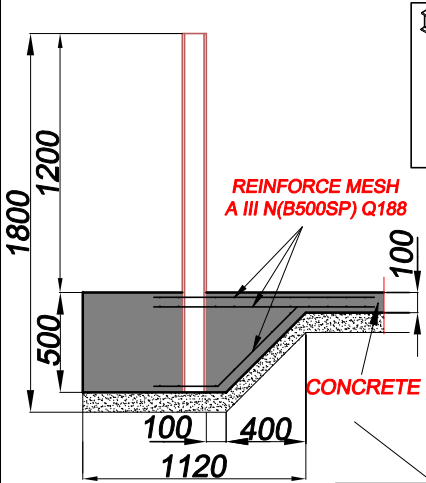
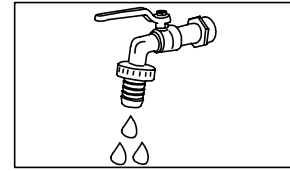
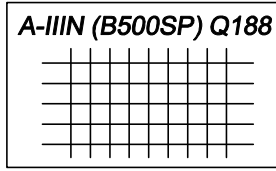
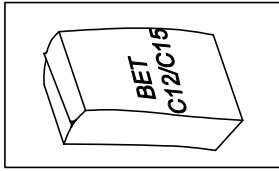

N.B. Soluzione non applicabile a un sistema autoportante. (Vedere pag. 38-39)

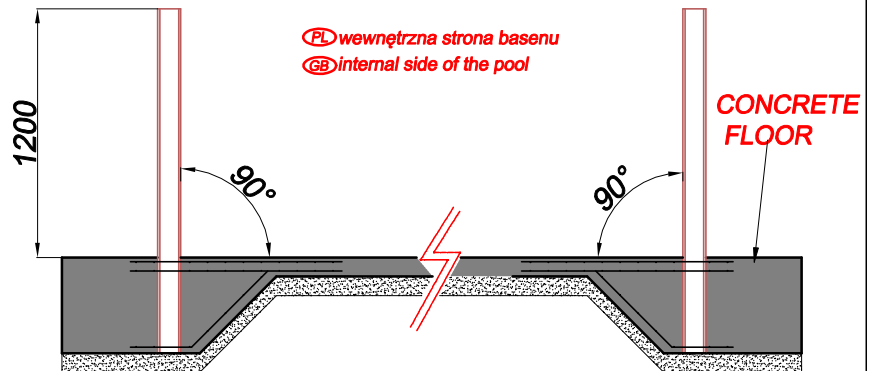
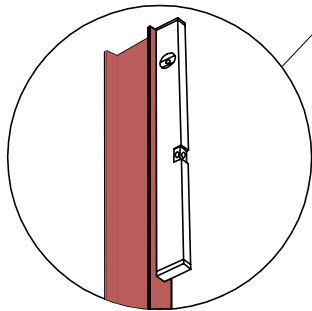
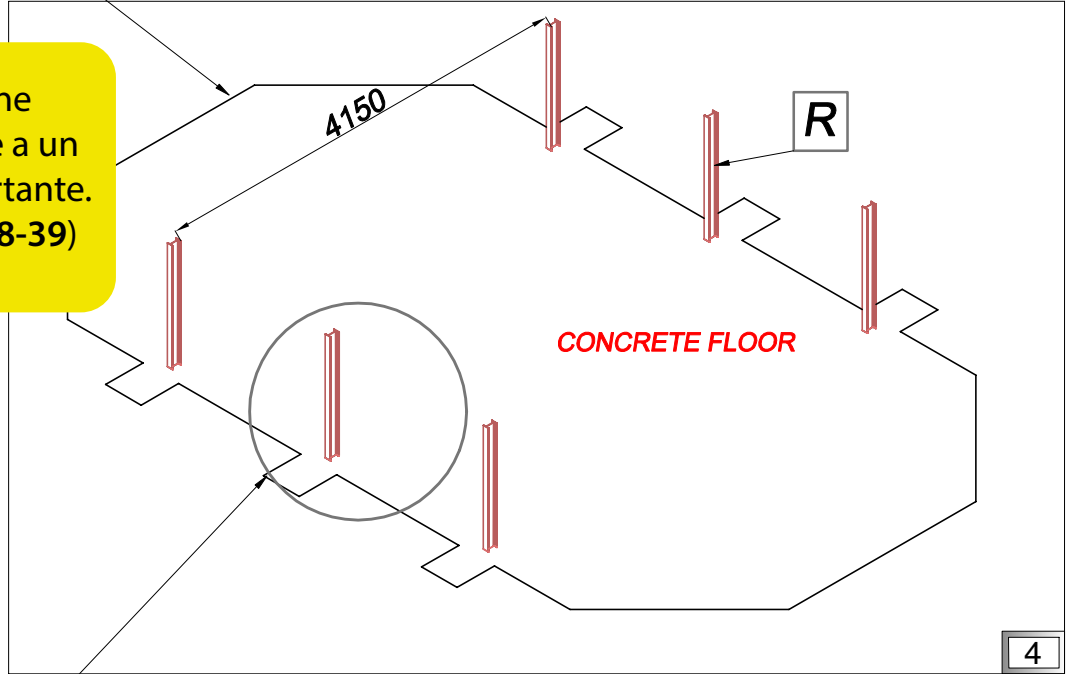

PL Podłoże

GB Ground

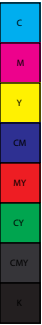
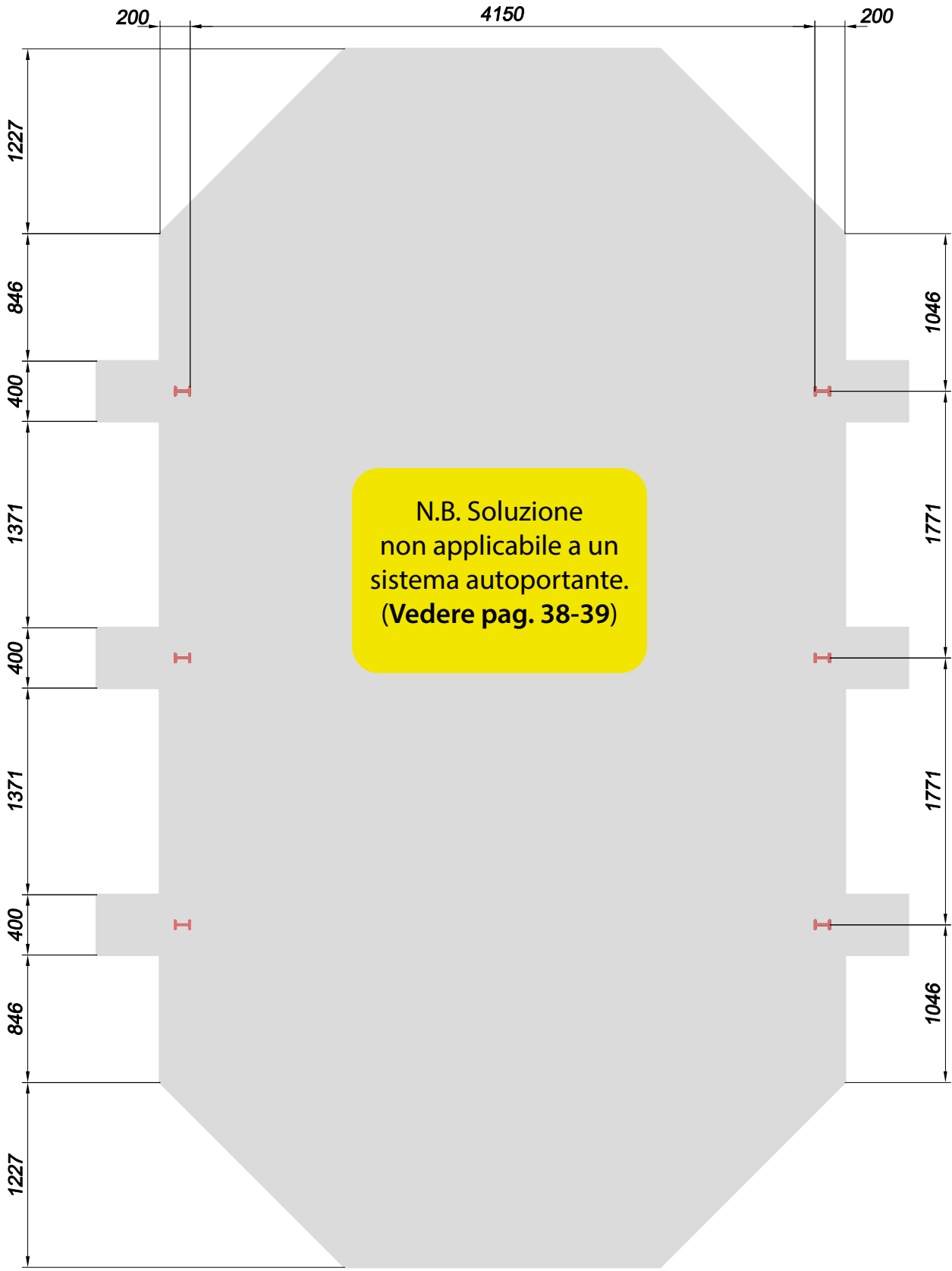



I

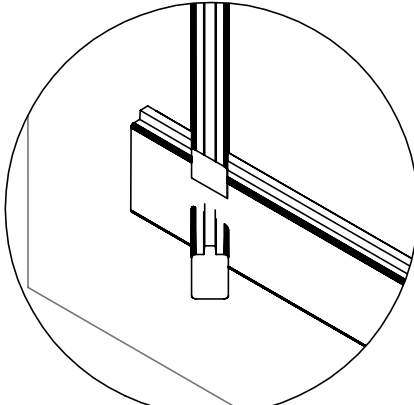
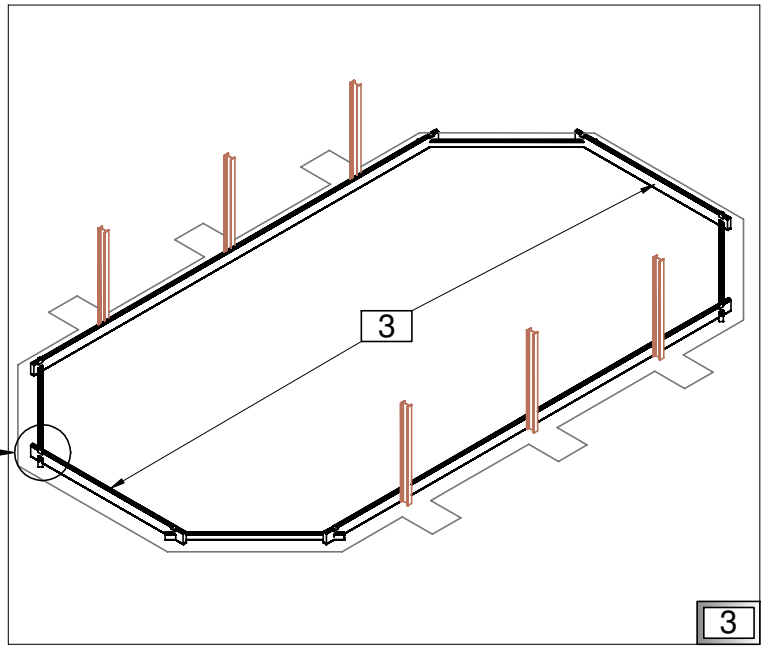
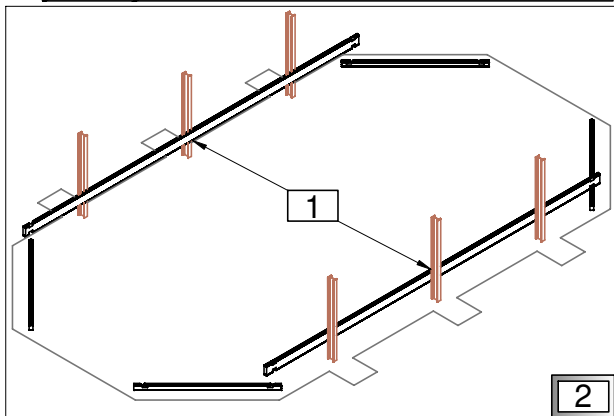
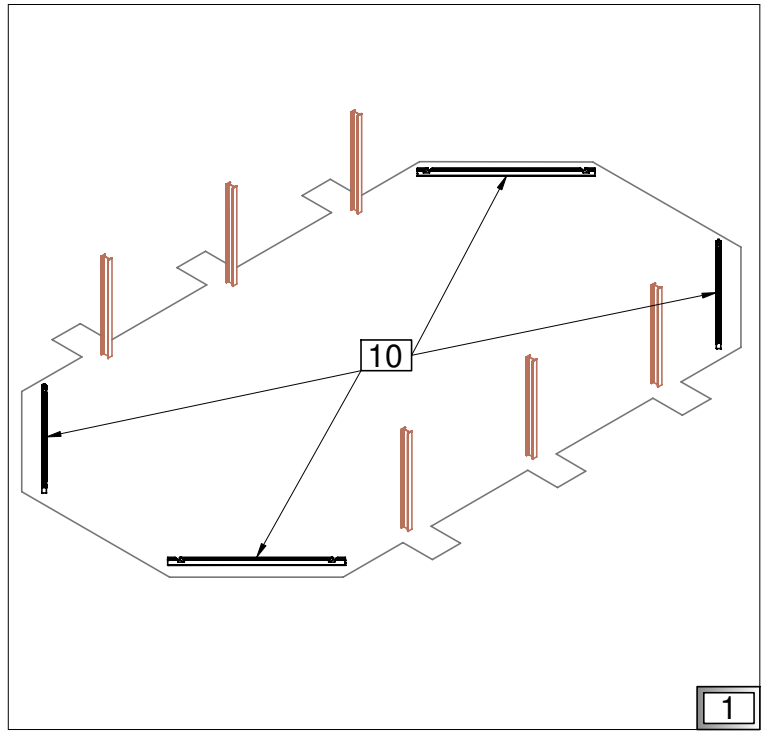
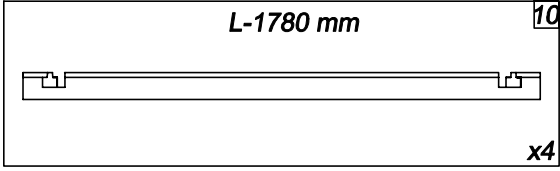
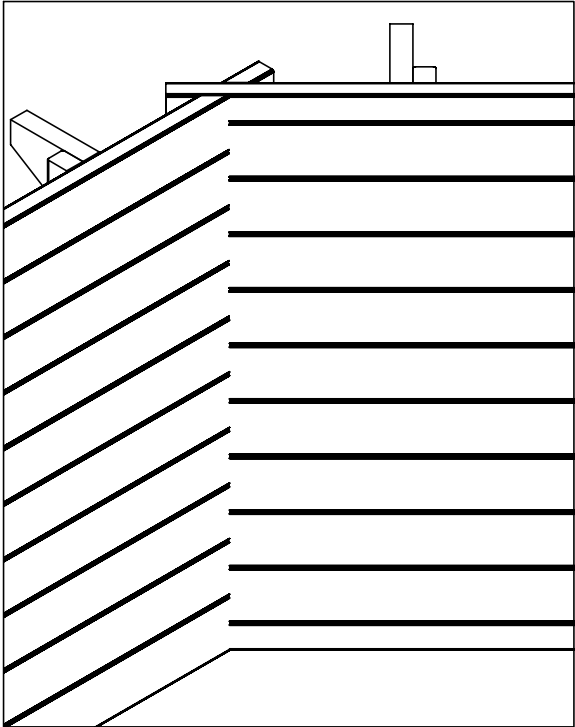
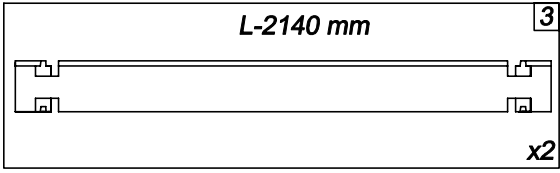
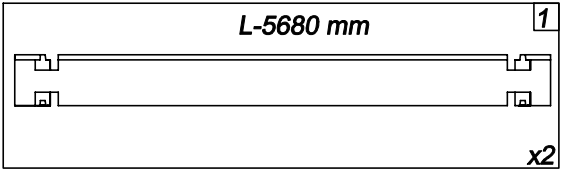

PL *Struktura drewniana*

GB *Wooden structure*

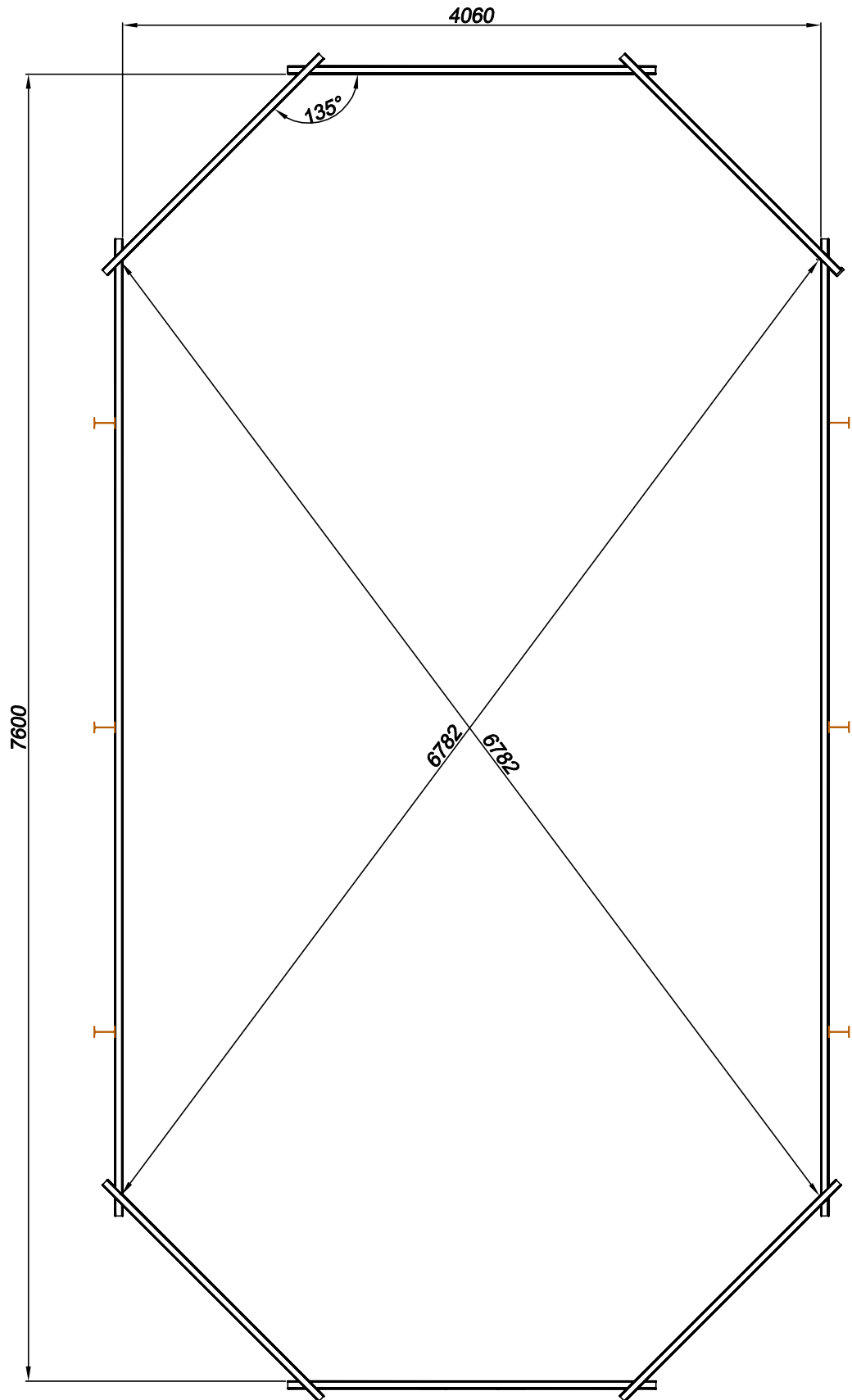



II-IV

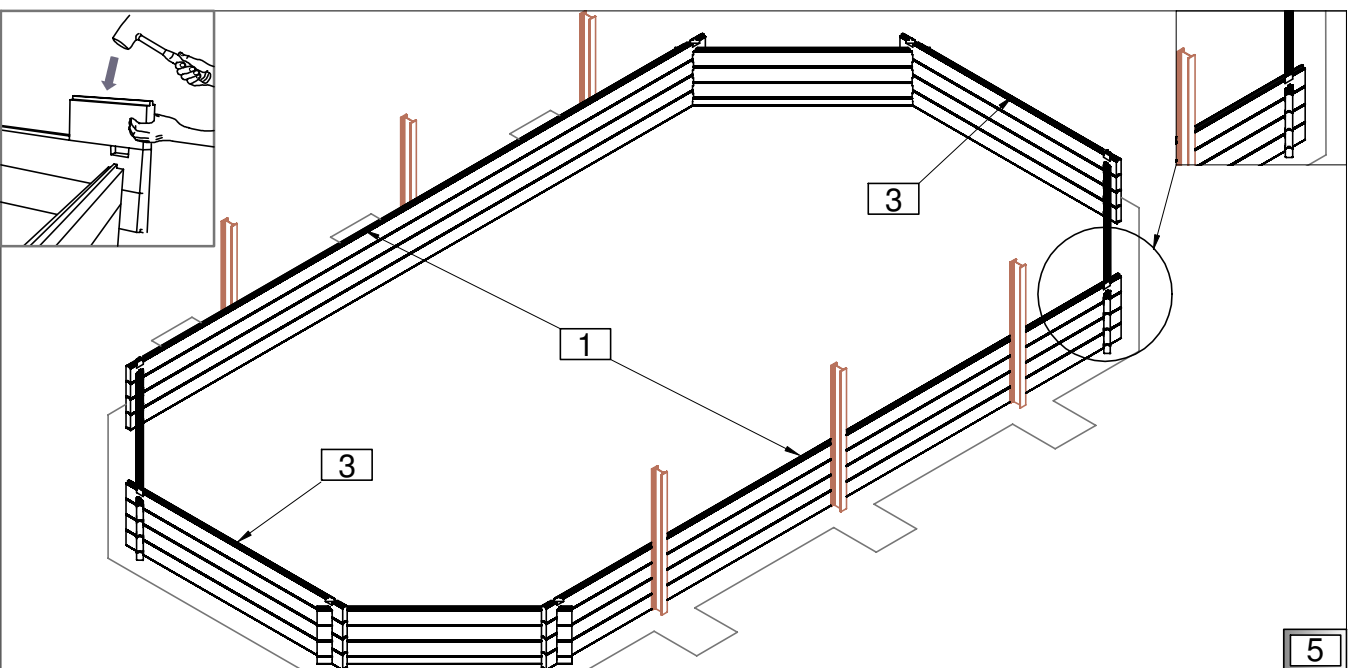
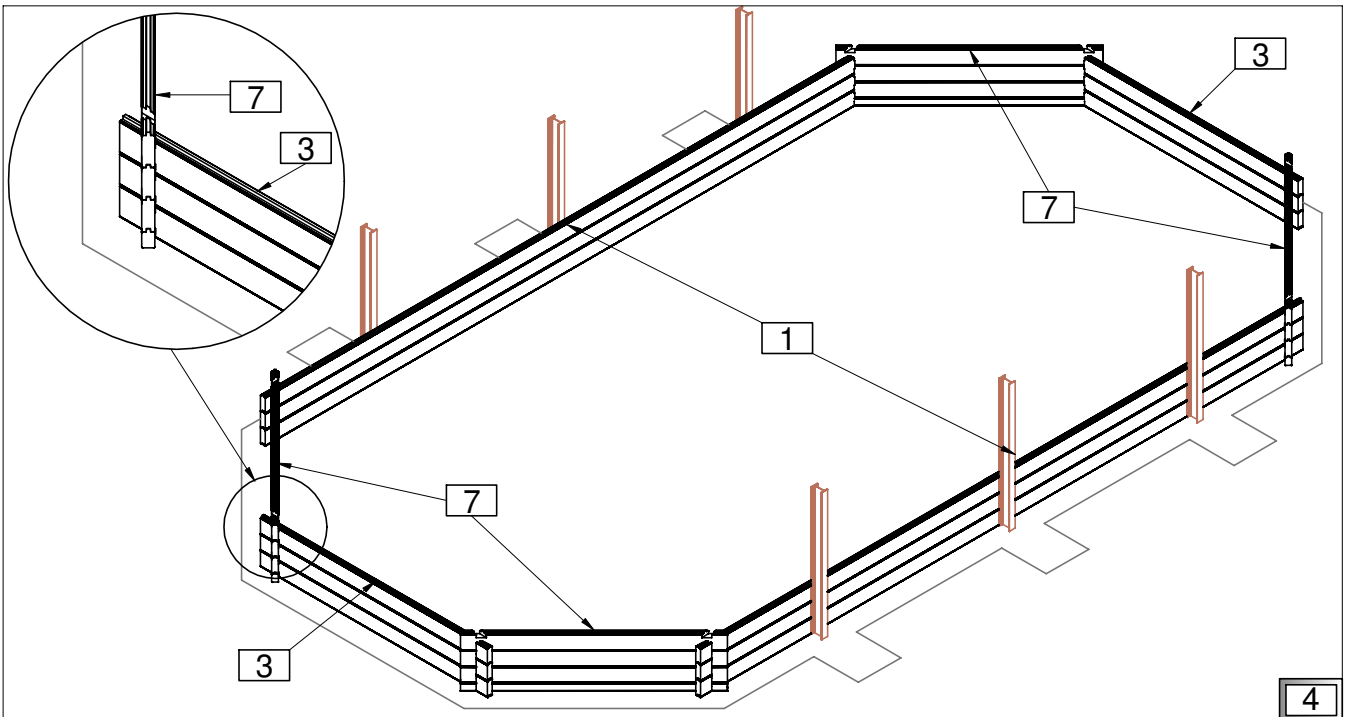
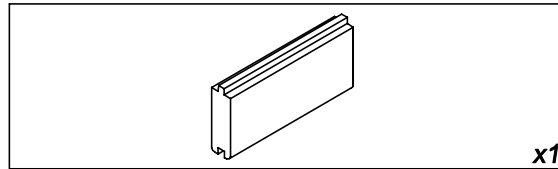
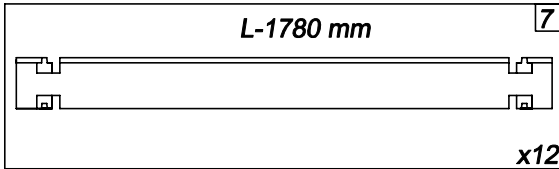
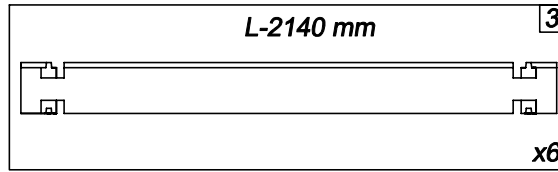
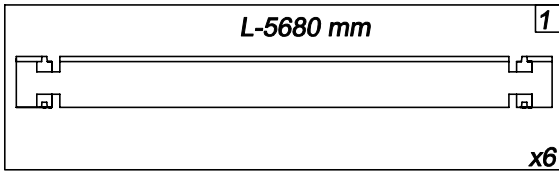

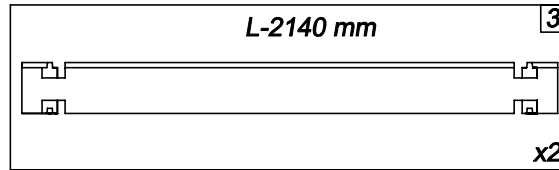
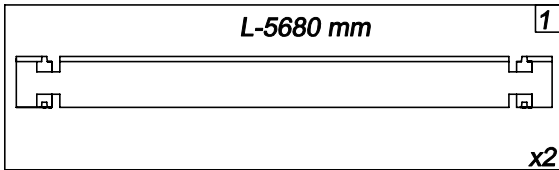

V

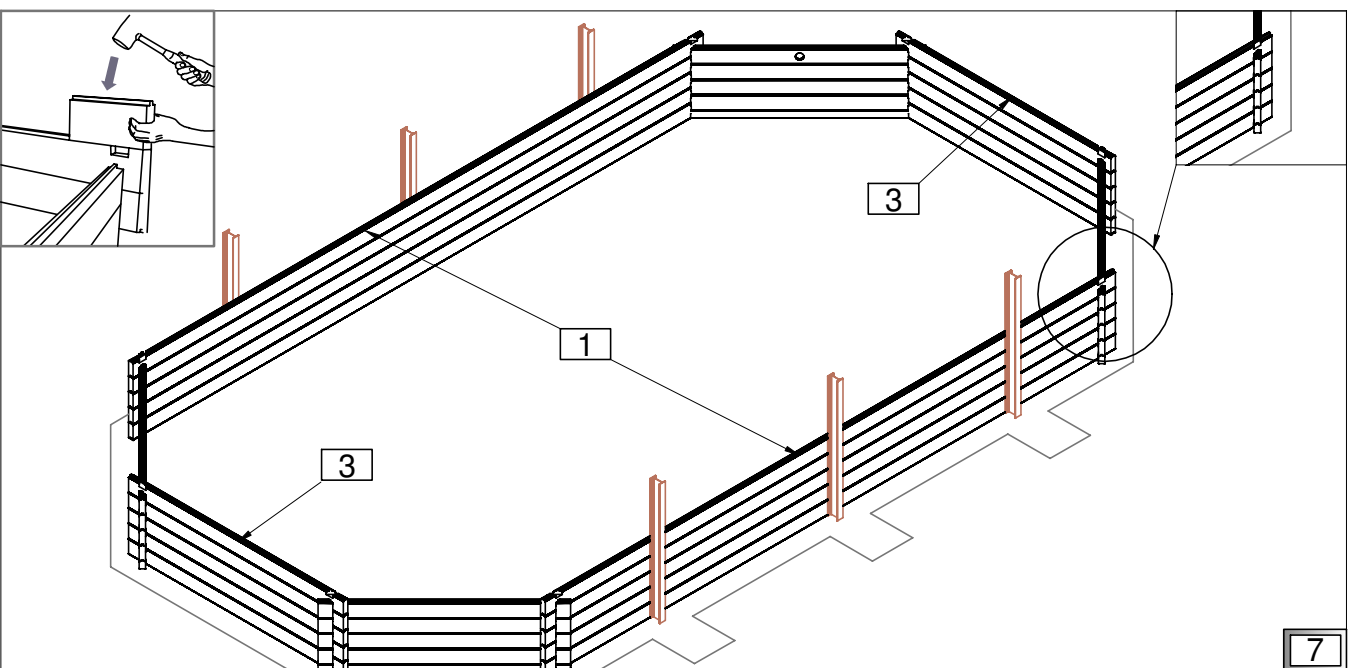
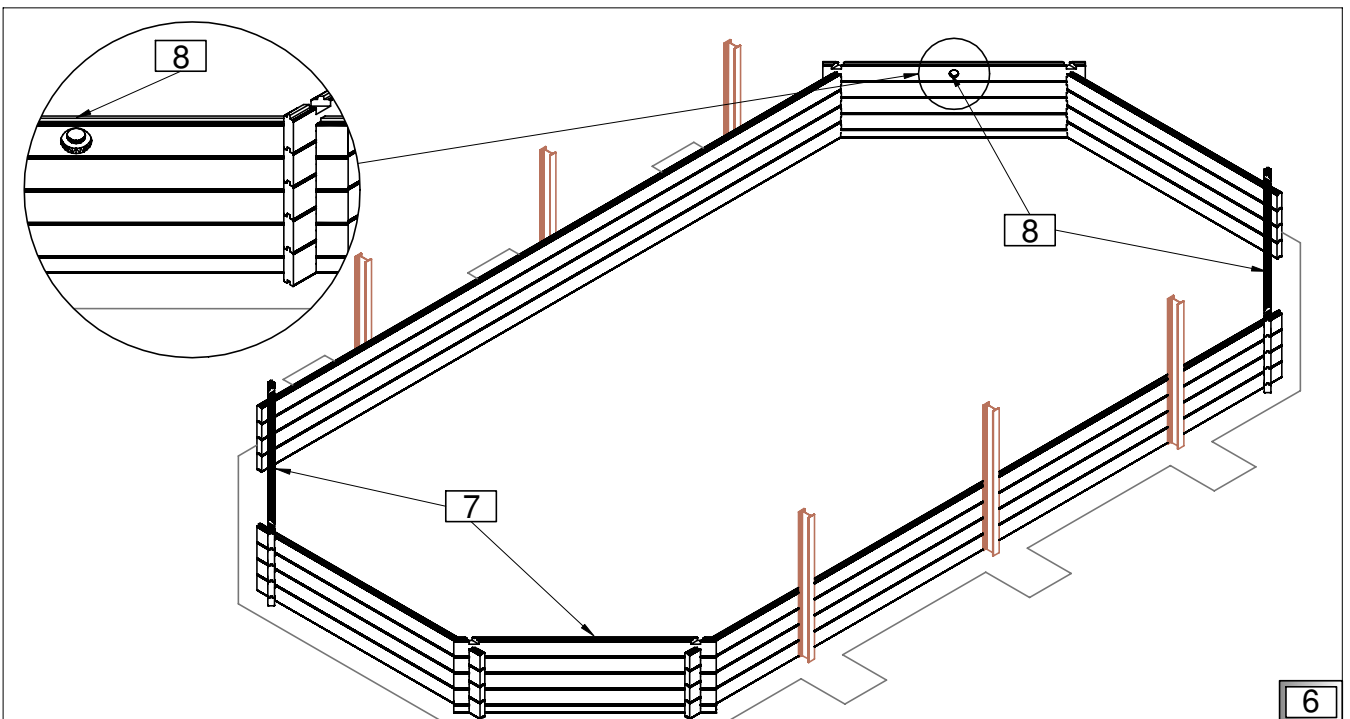
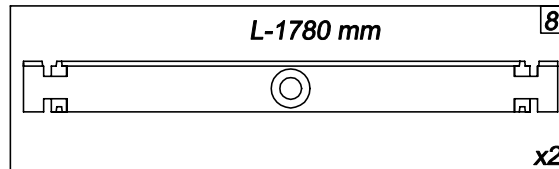
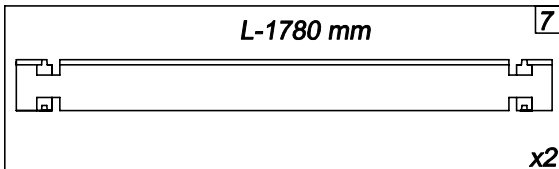



VI-VIII

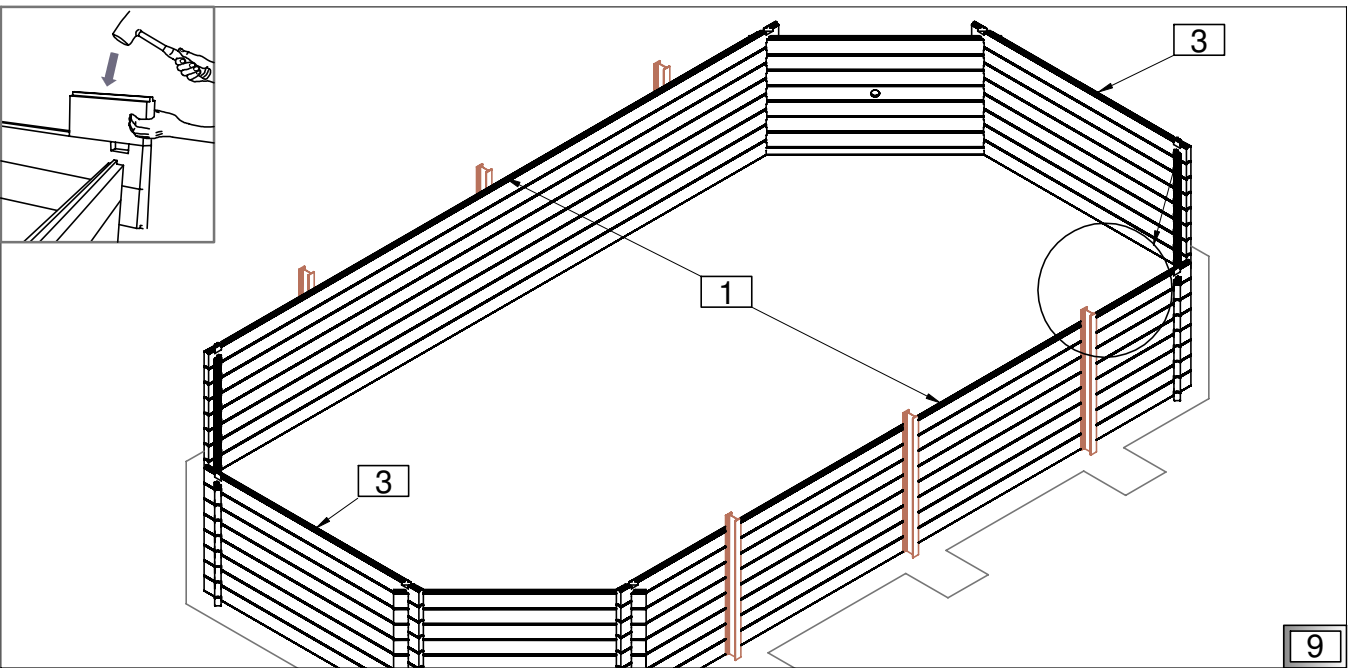
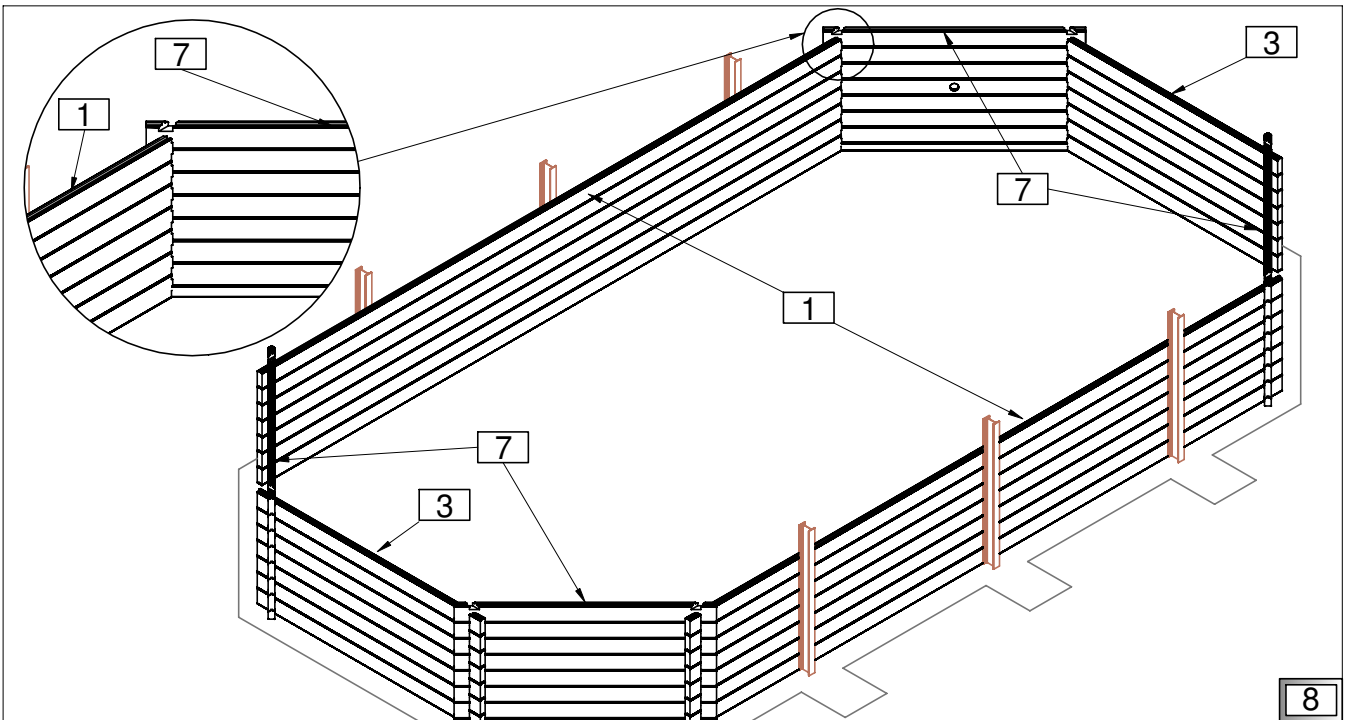
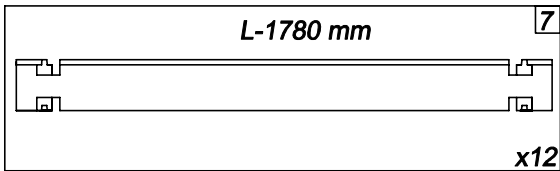
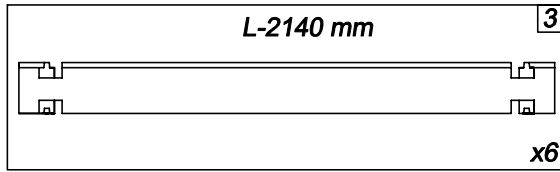
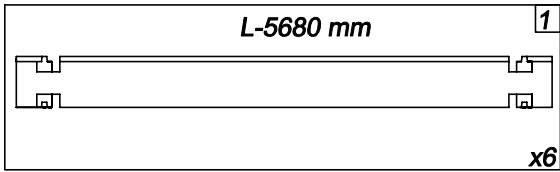



IX

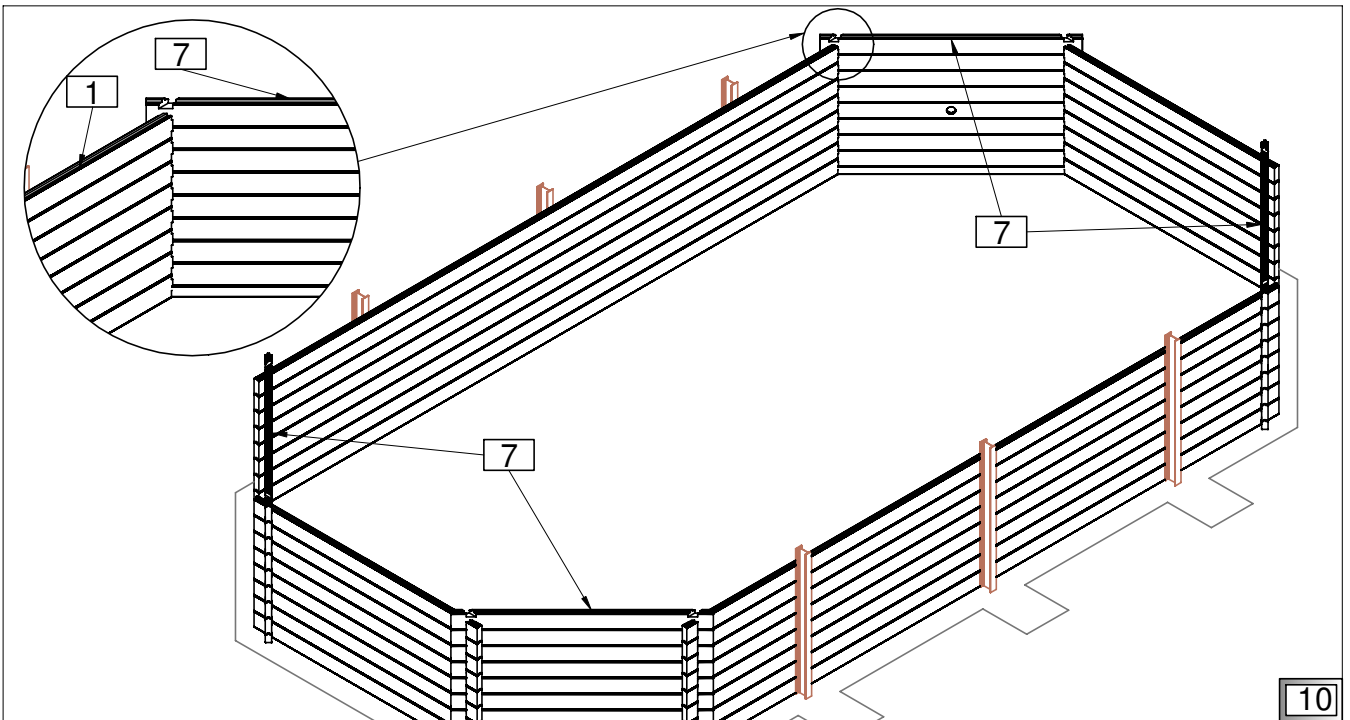
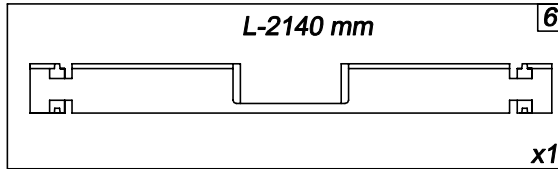
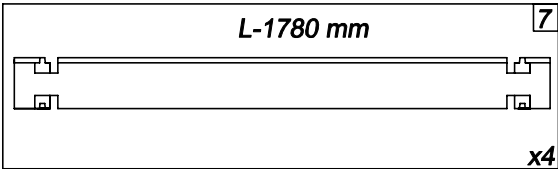
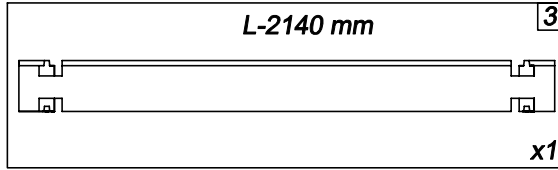
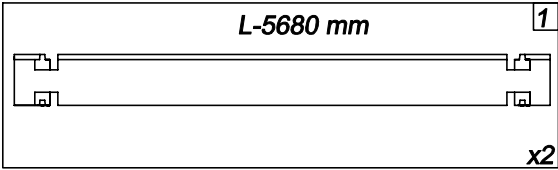

10

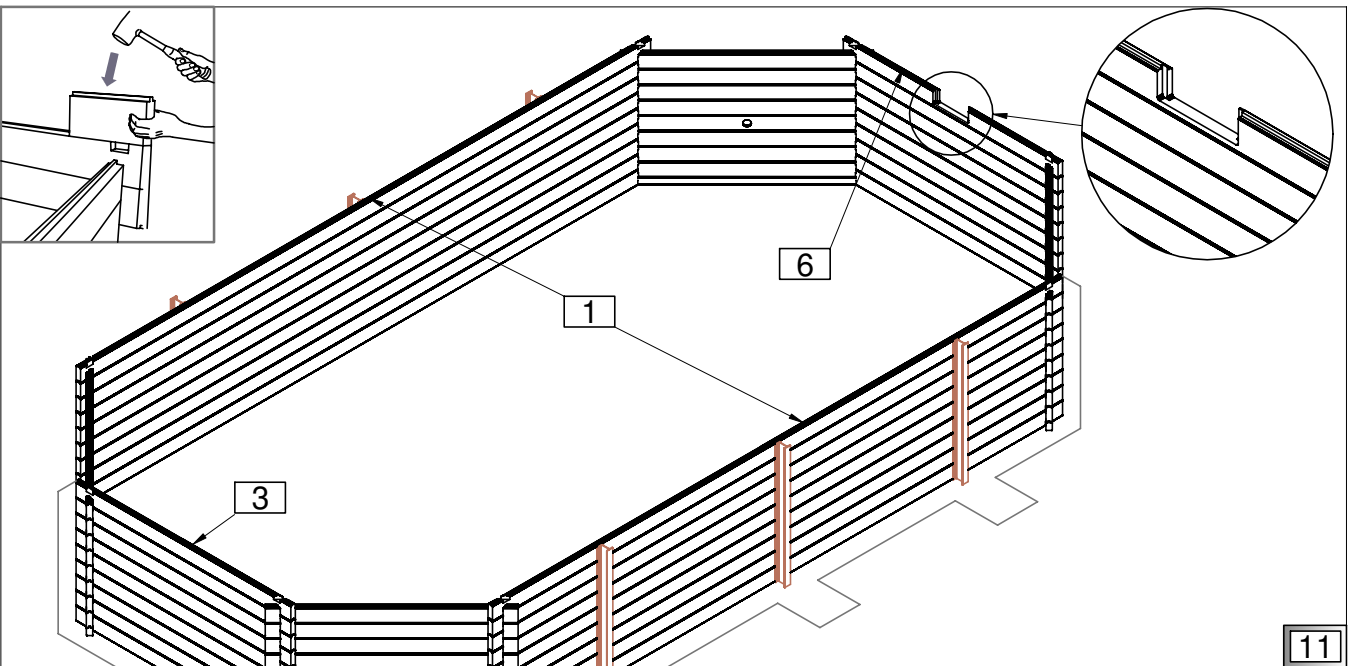

11

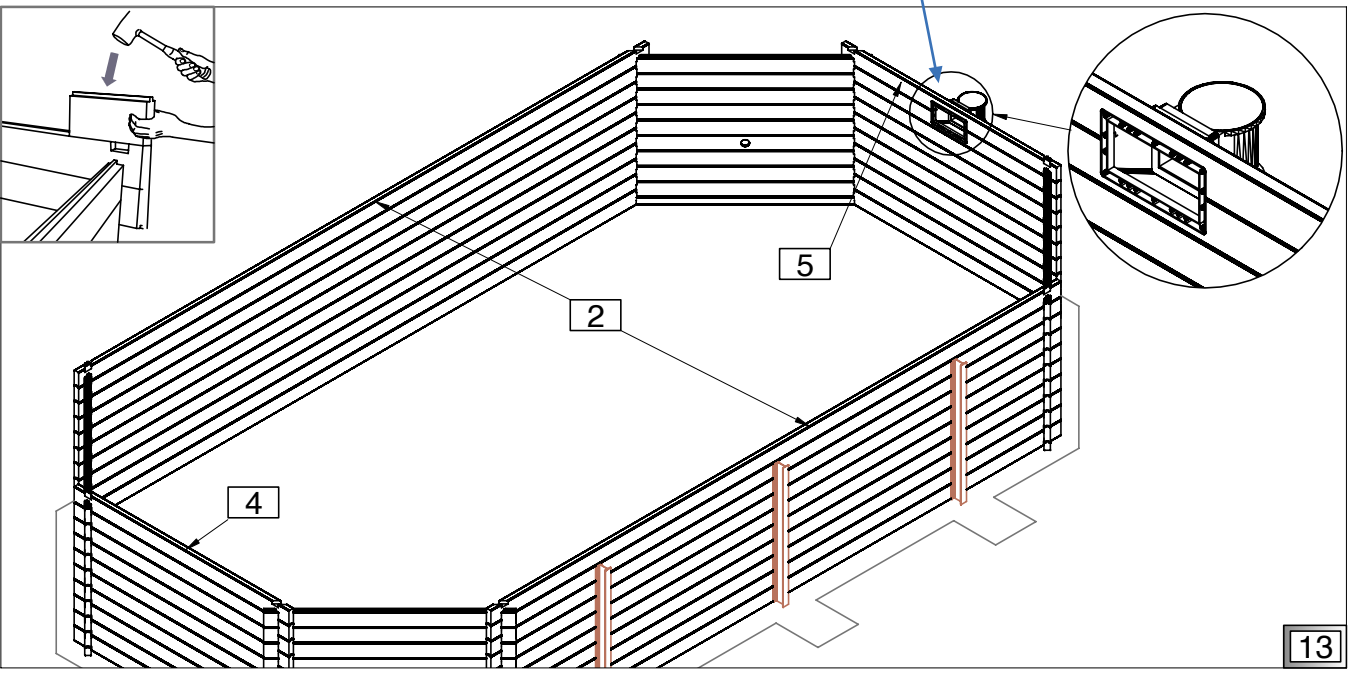
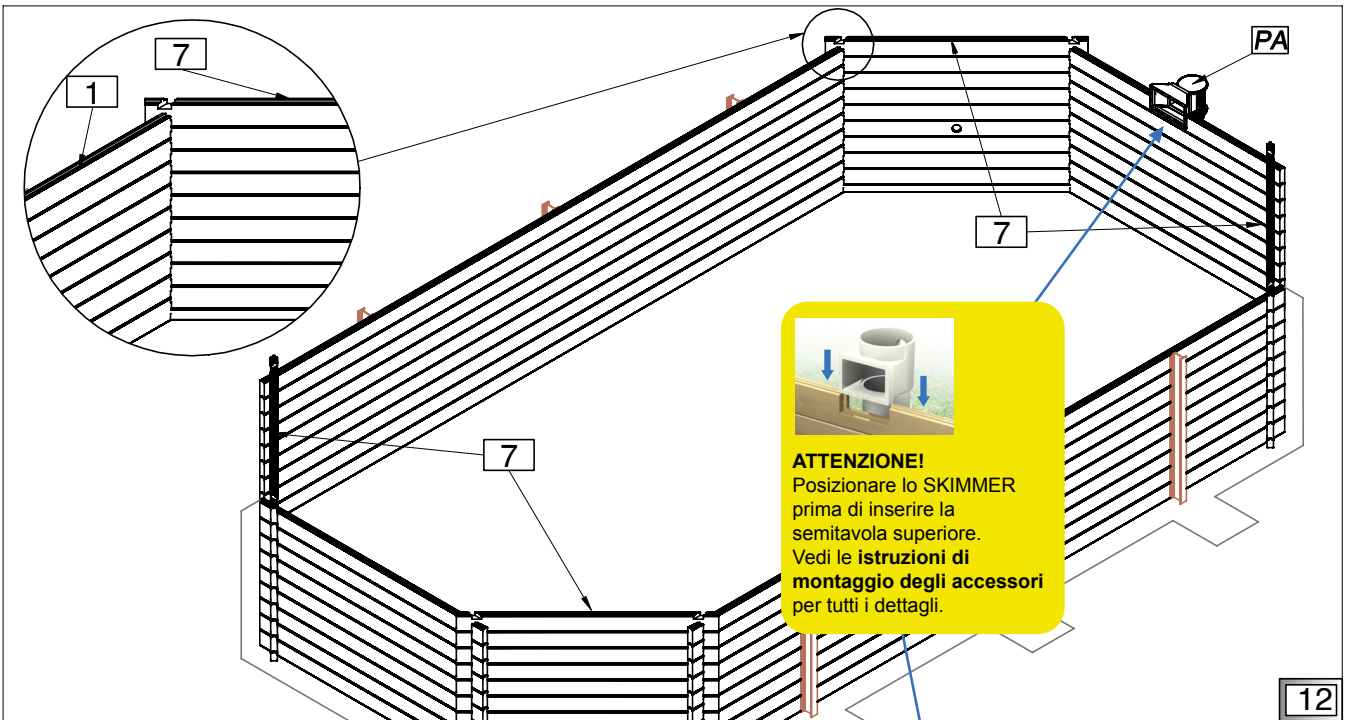
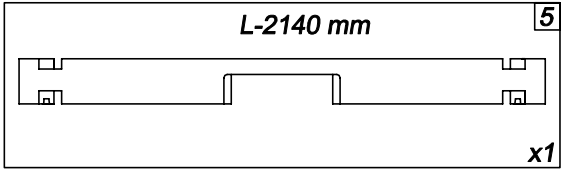
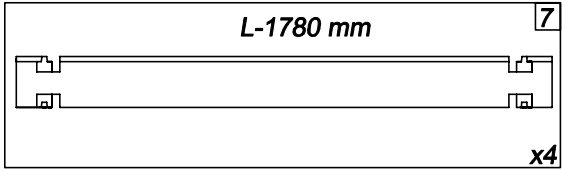
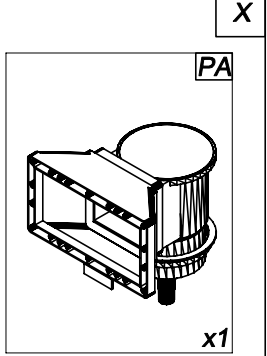
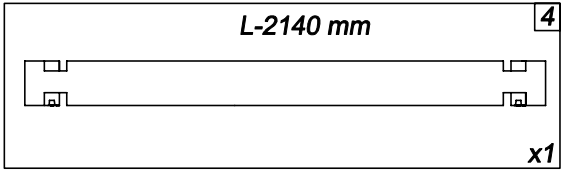
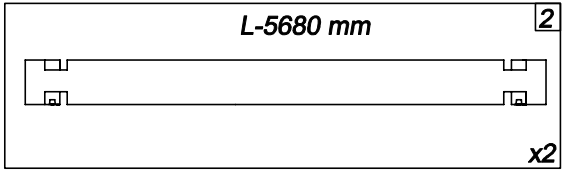



XI

L-1780 mm

9

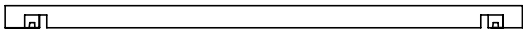

x4

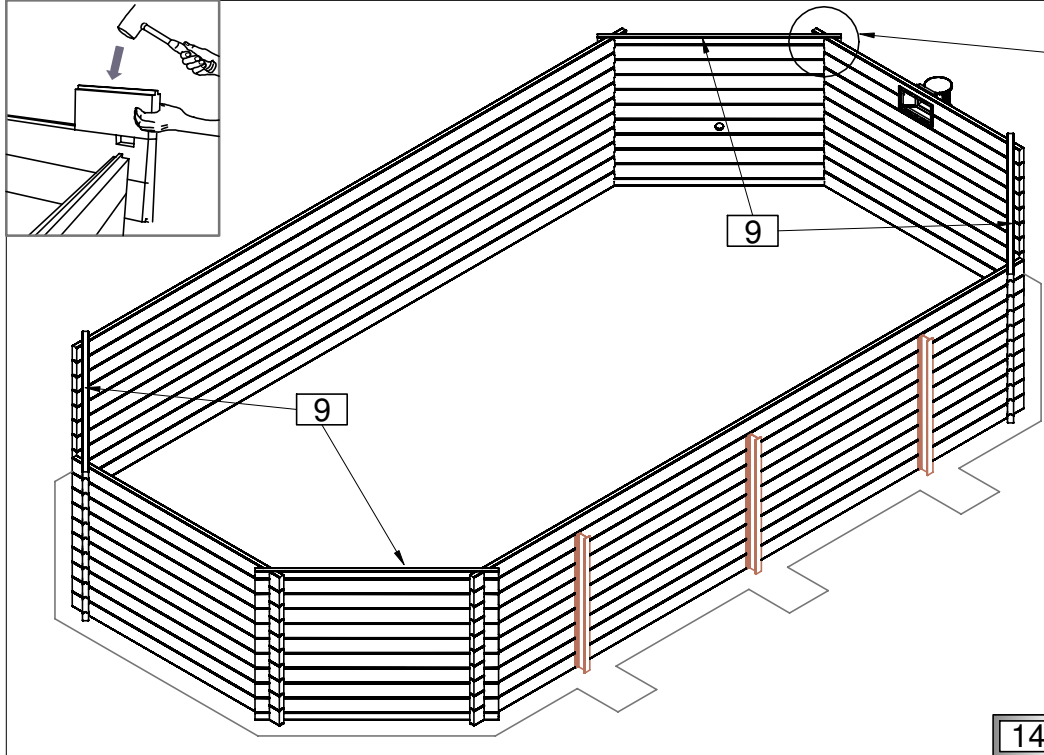
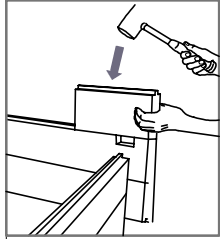

14

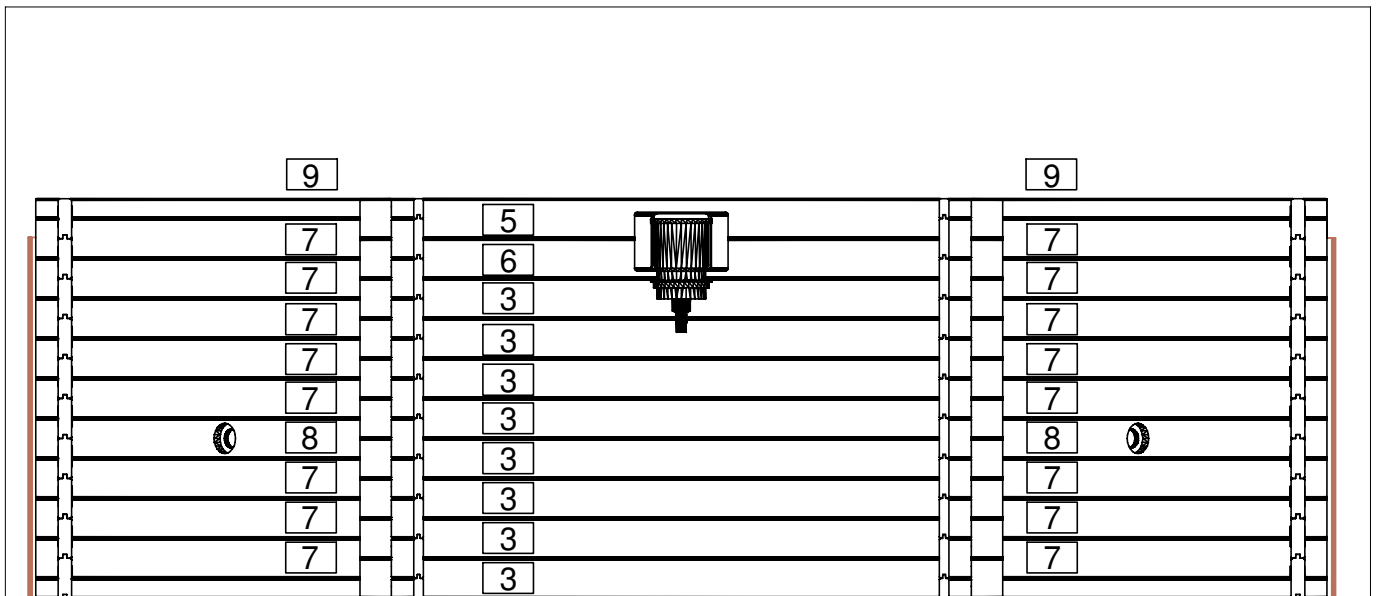



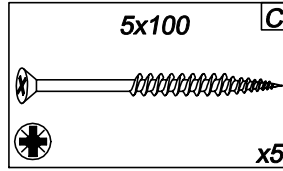
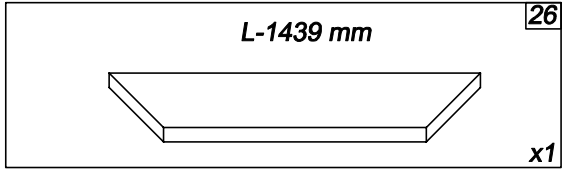

15

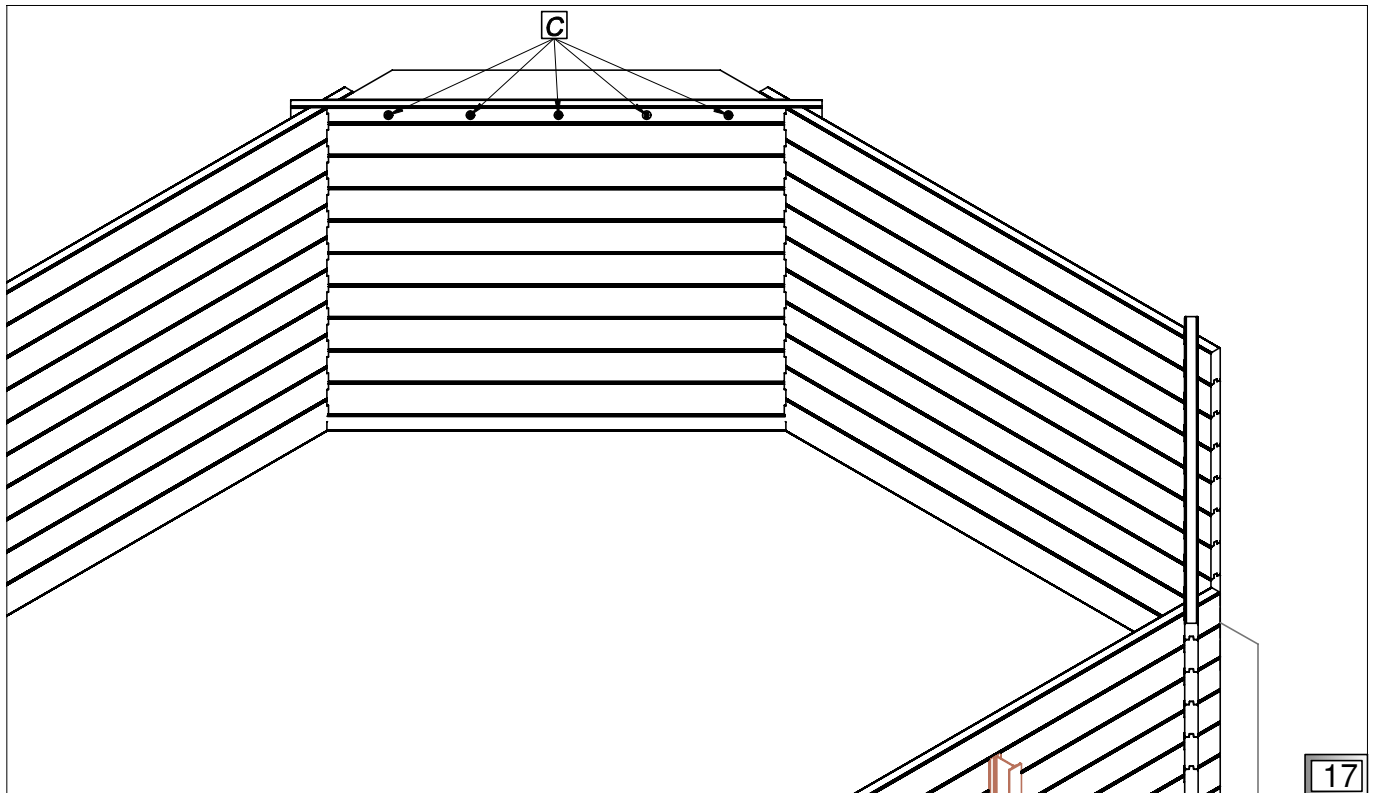
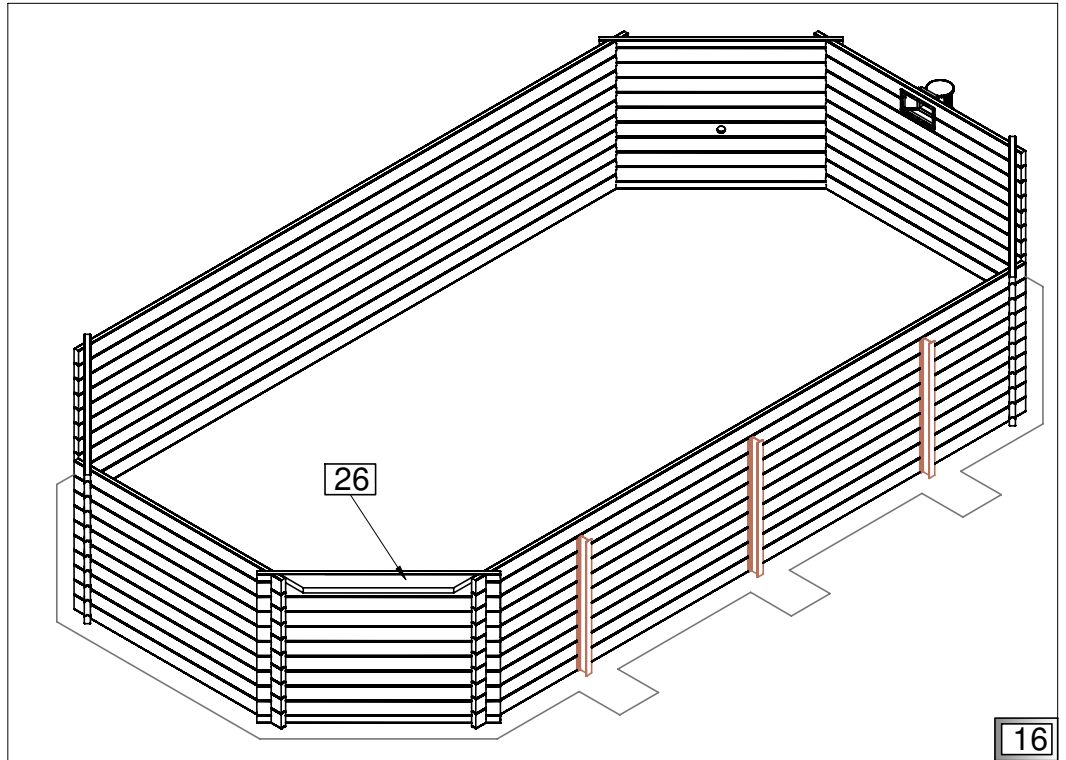

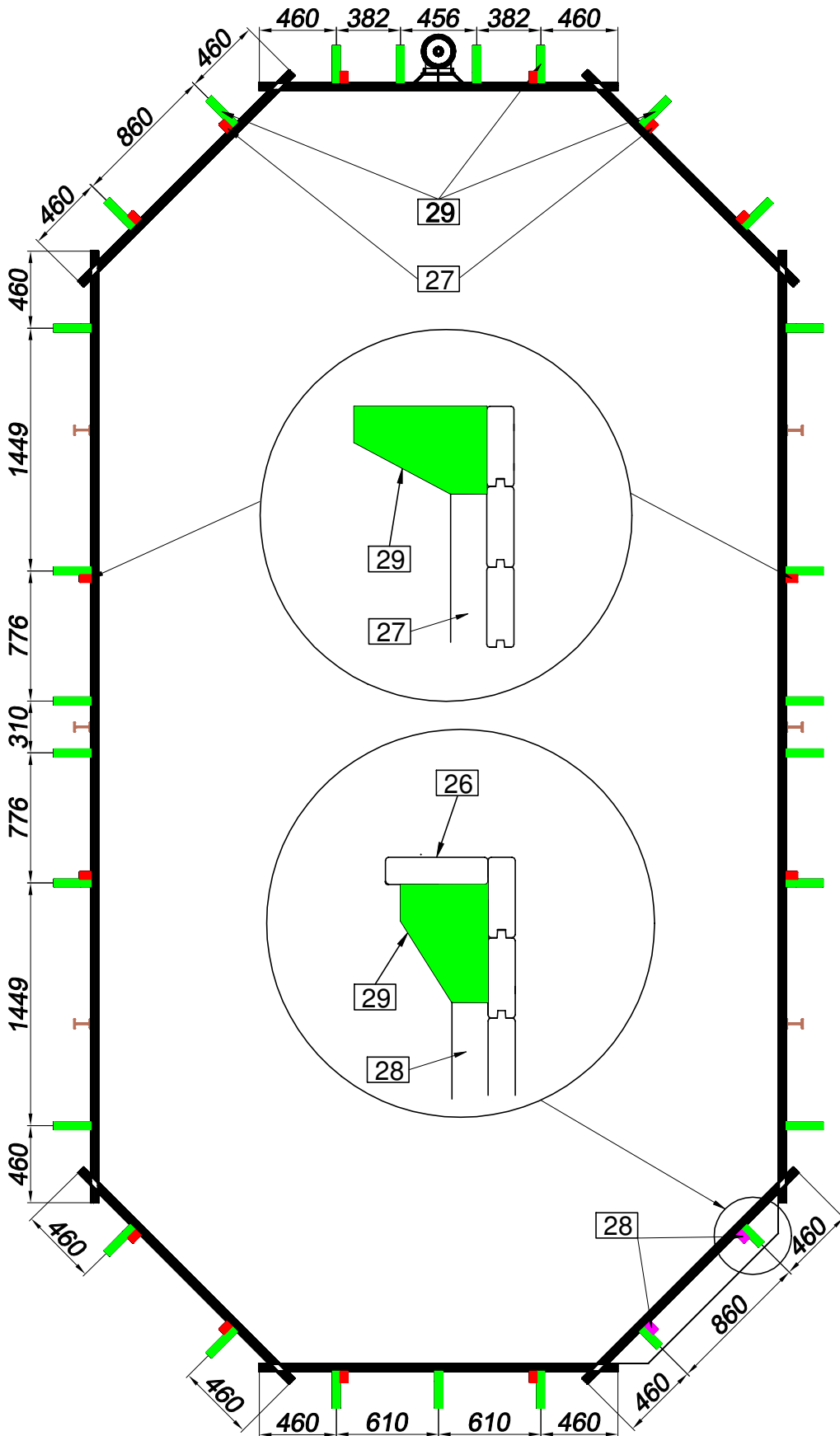
XI





-  29
-  27
-  28

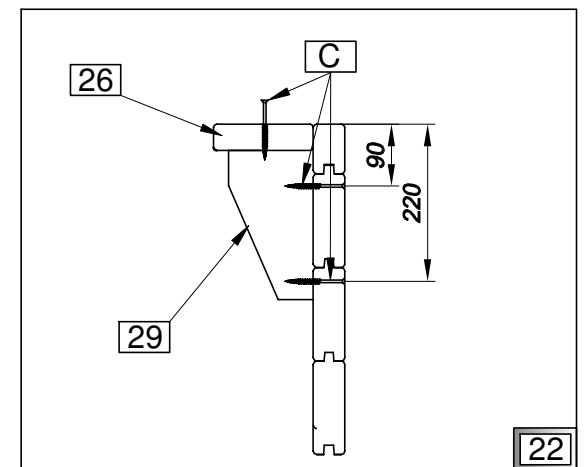
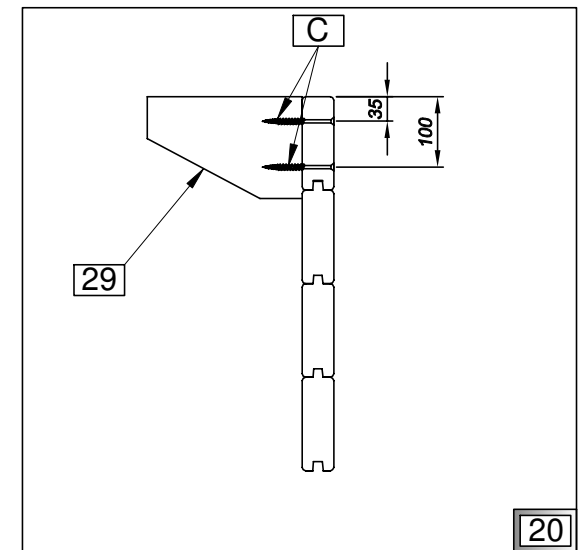
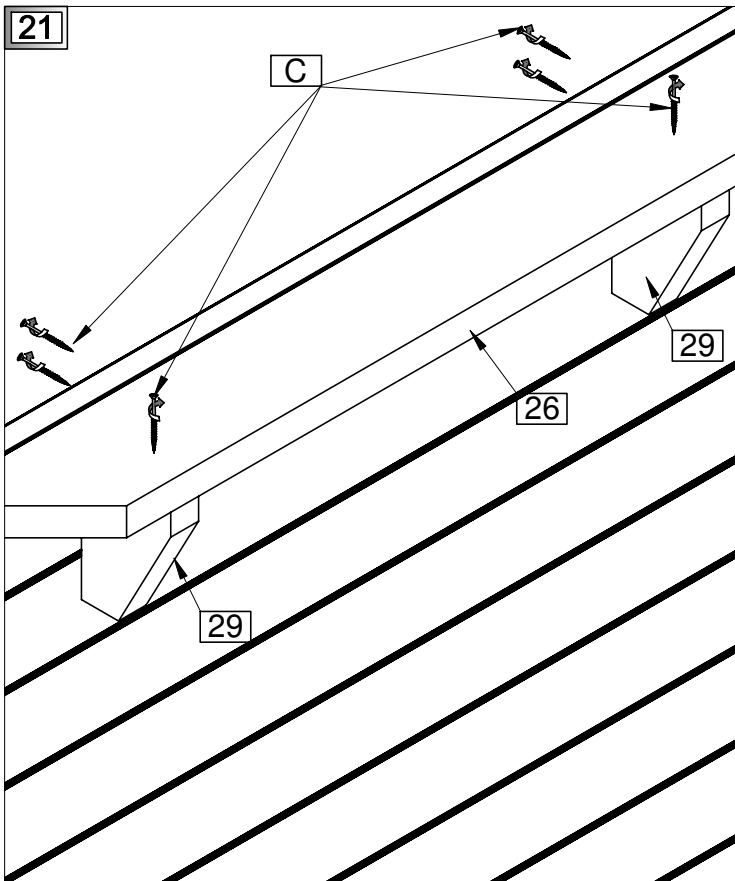
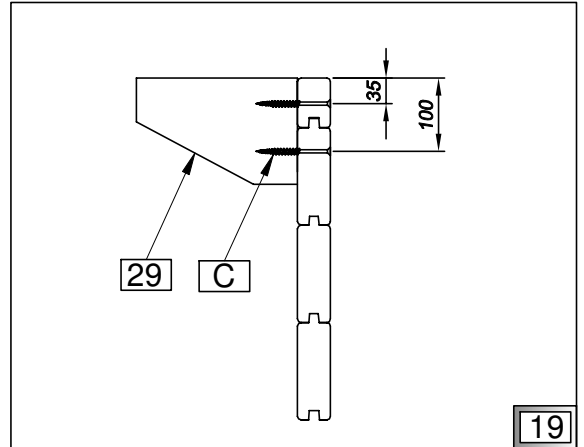
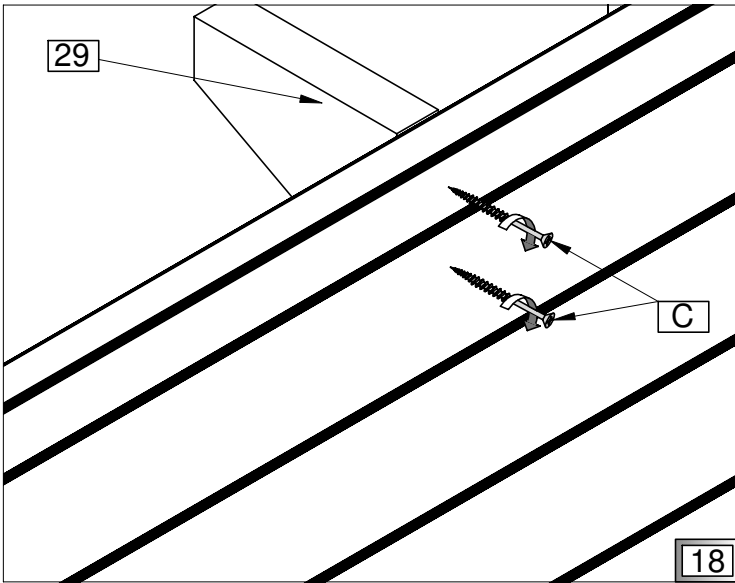
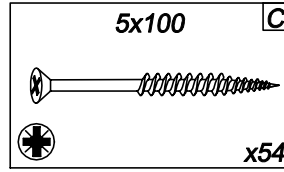
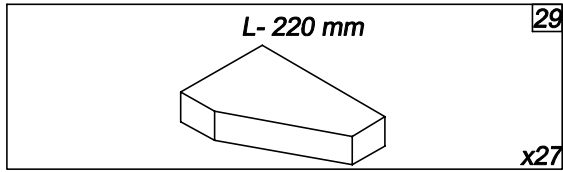

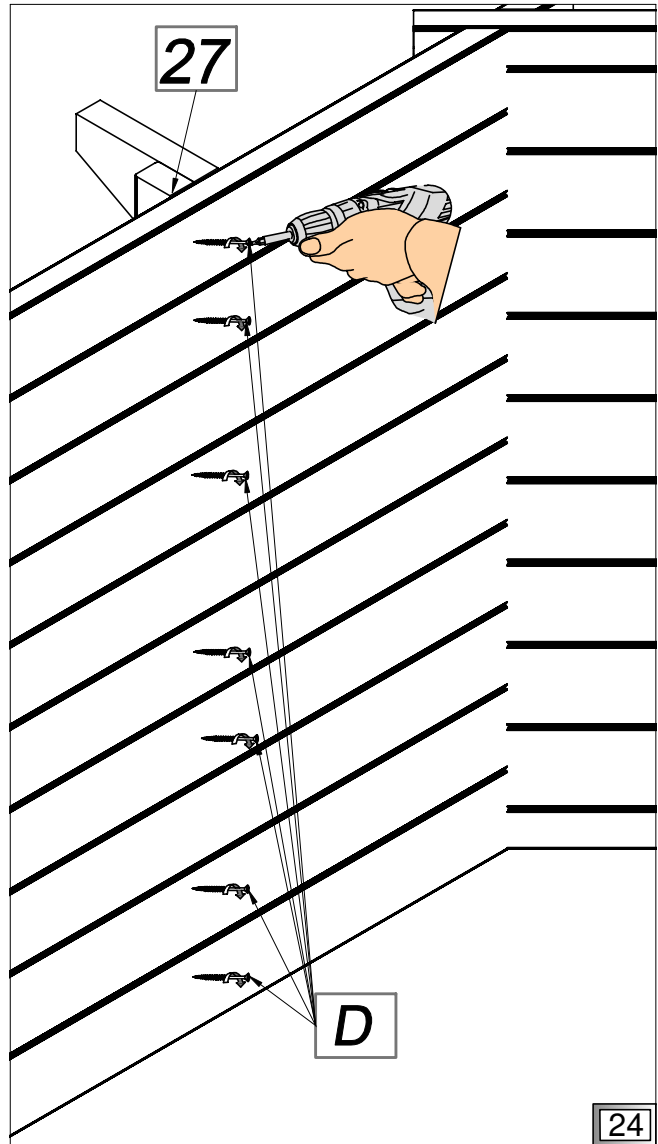
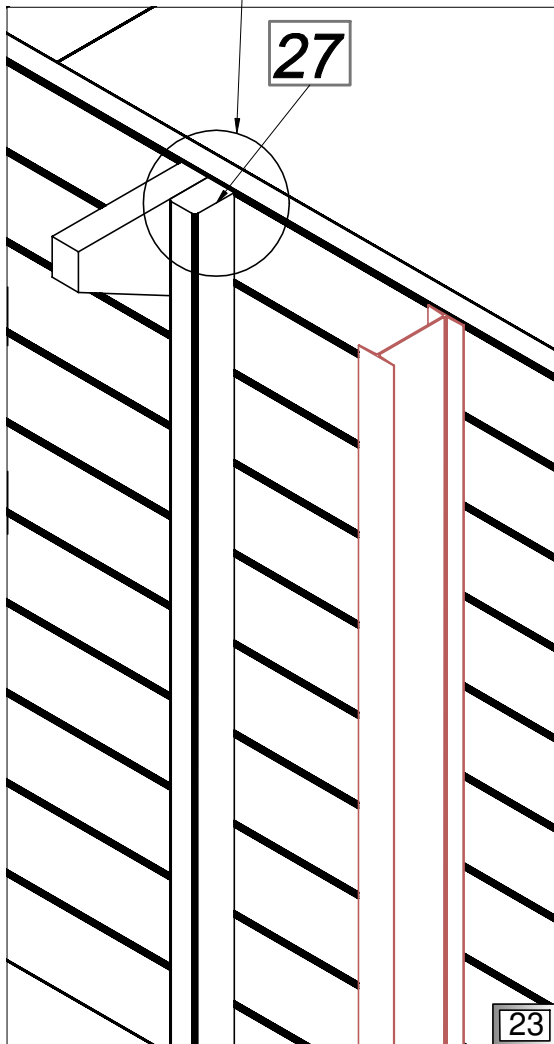
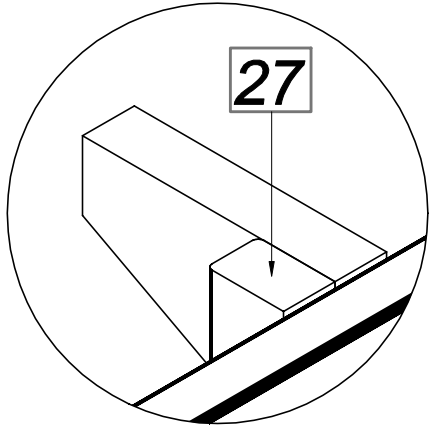
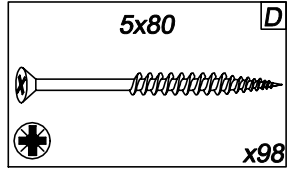
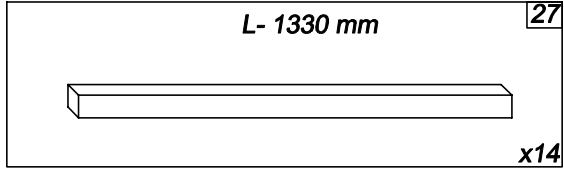

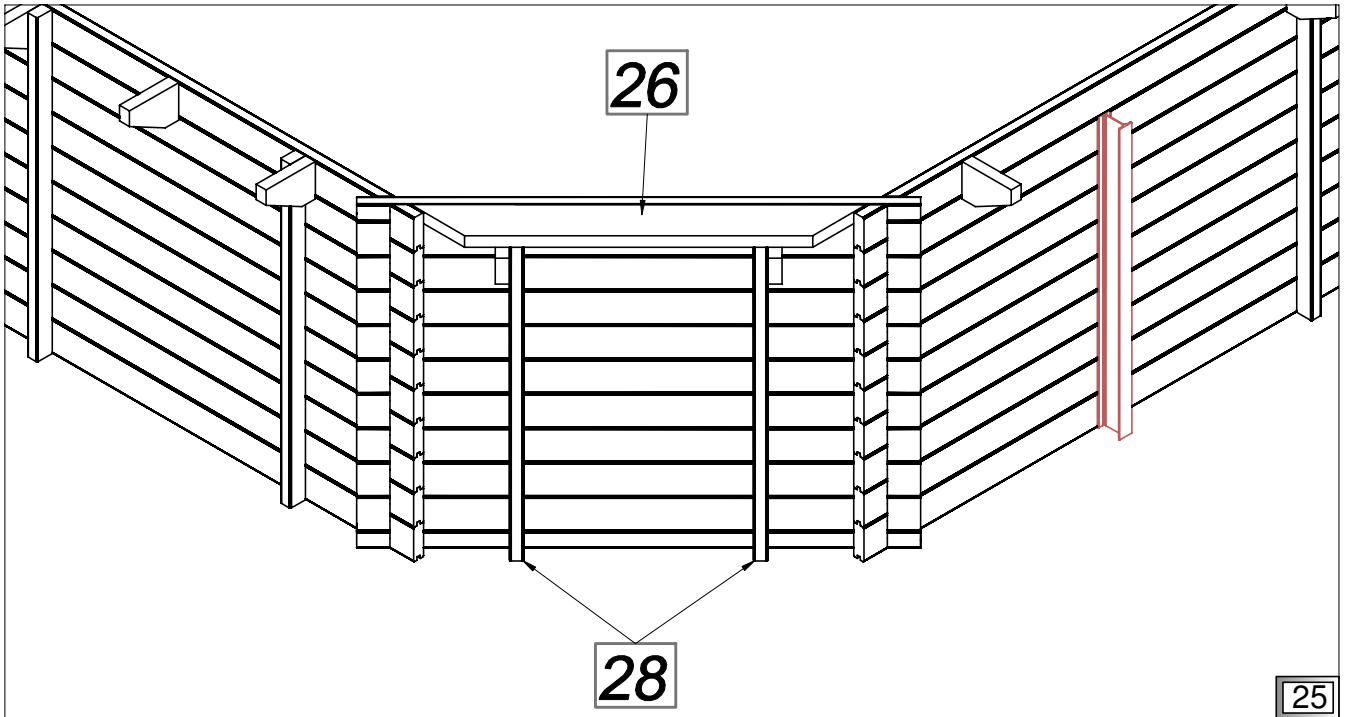
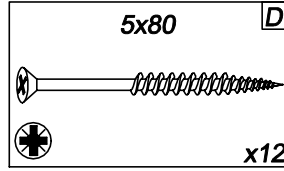
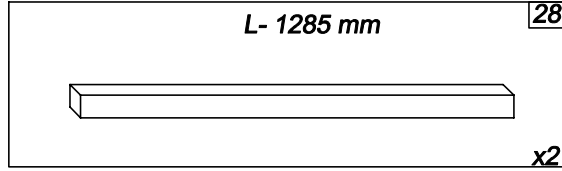

25

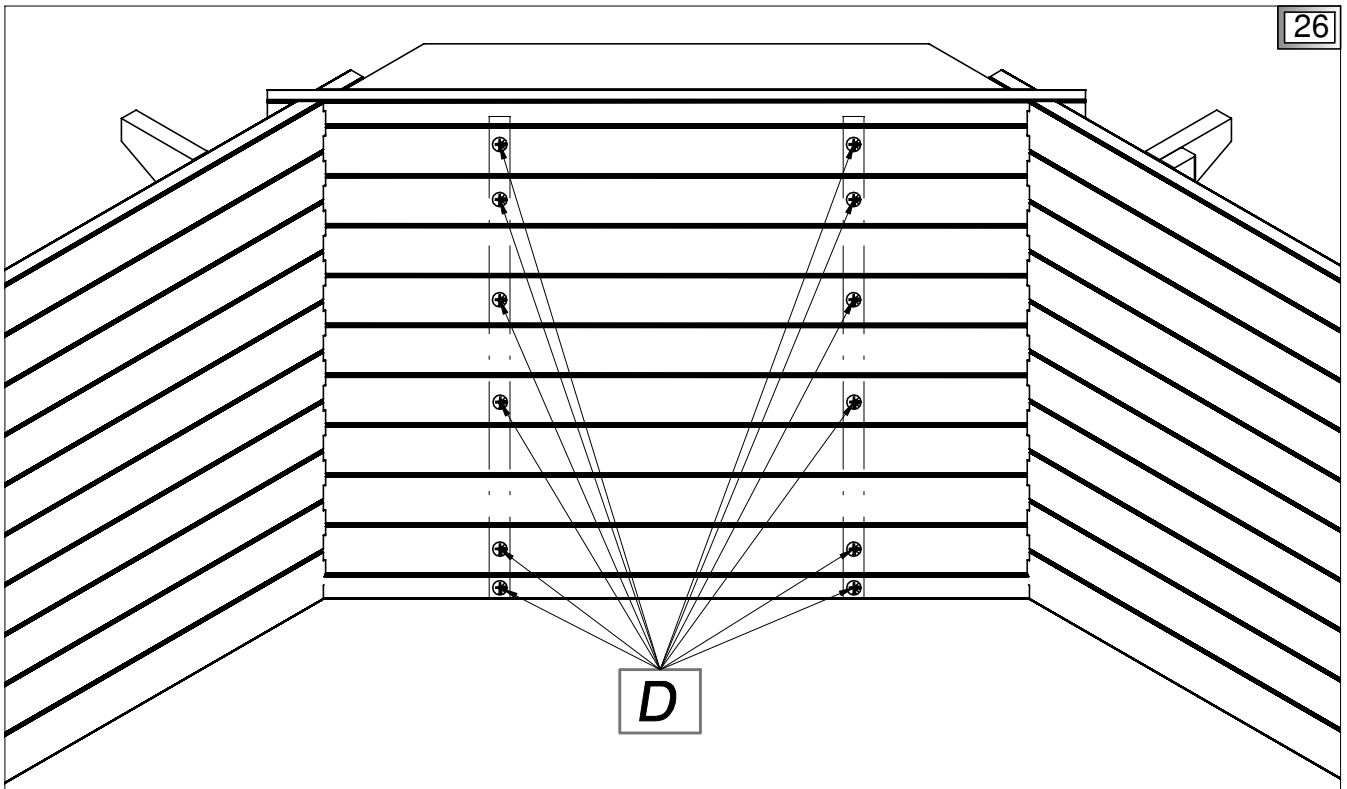

26

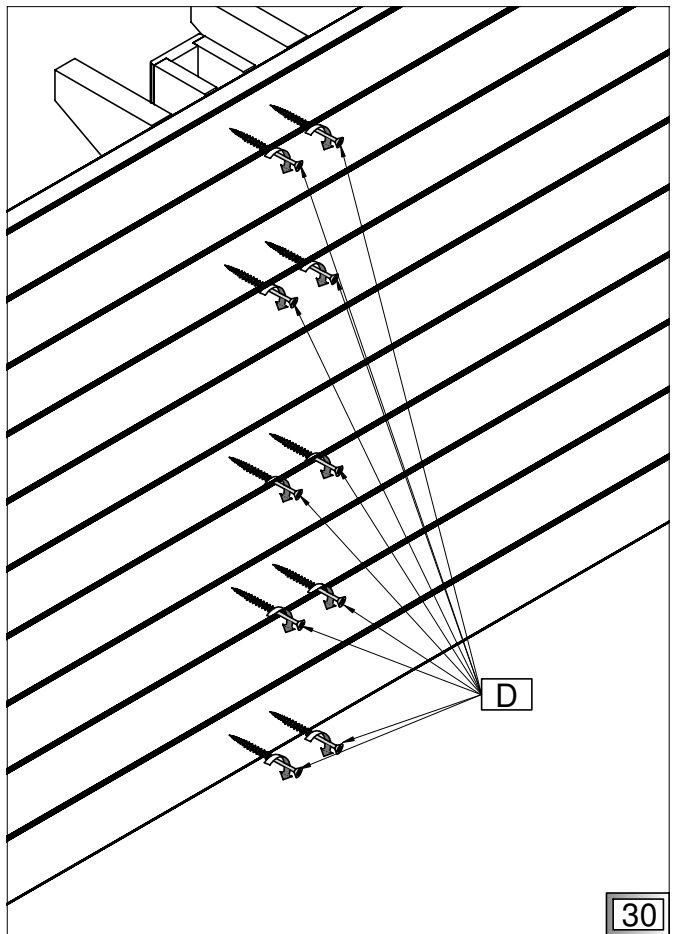
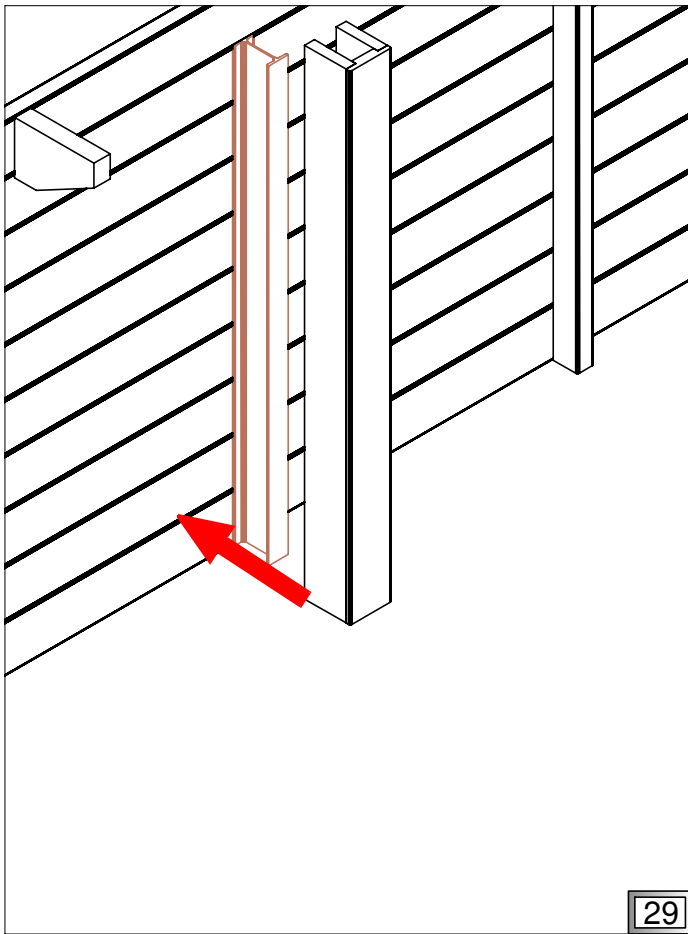
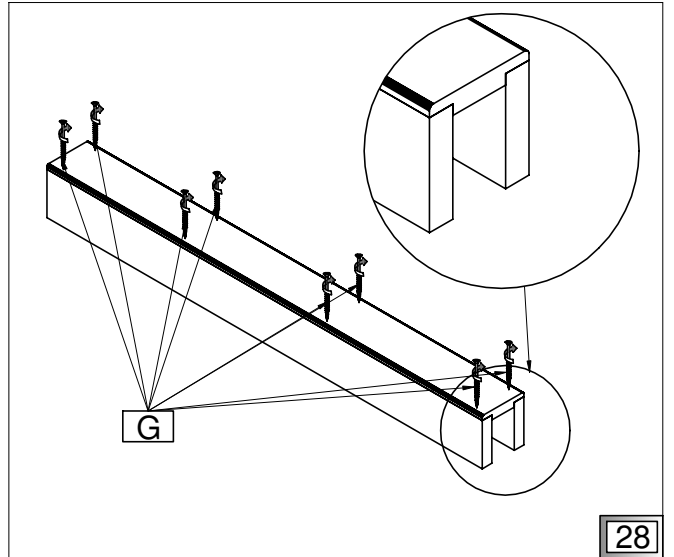
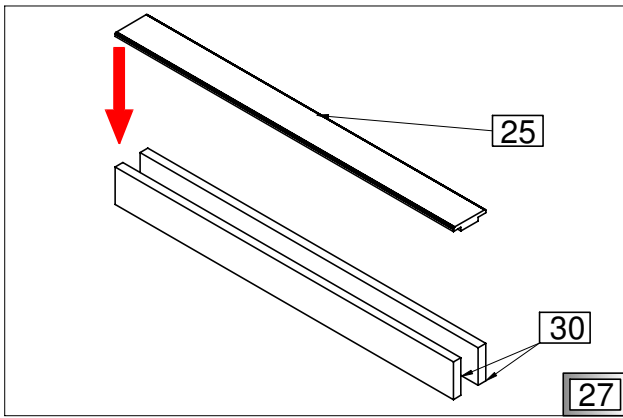
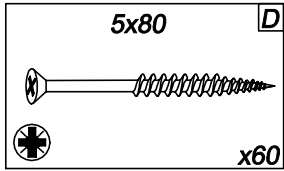
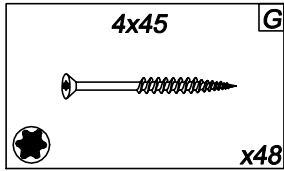
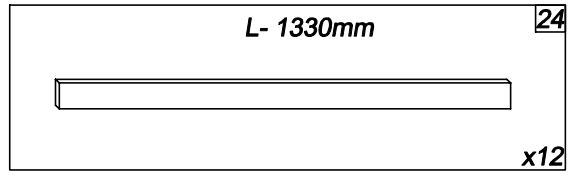
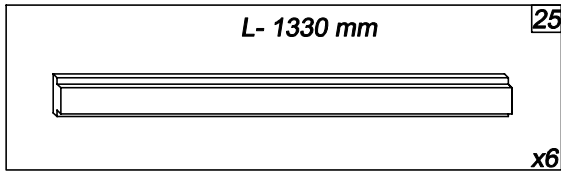

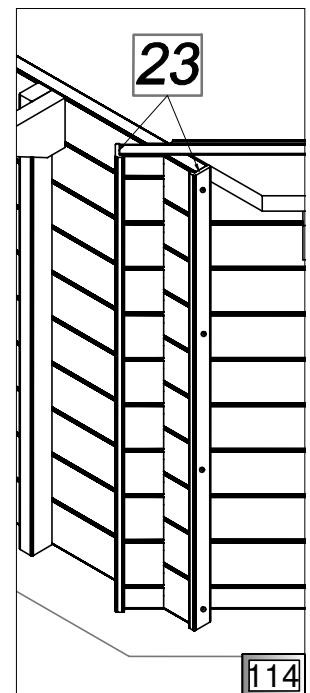
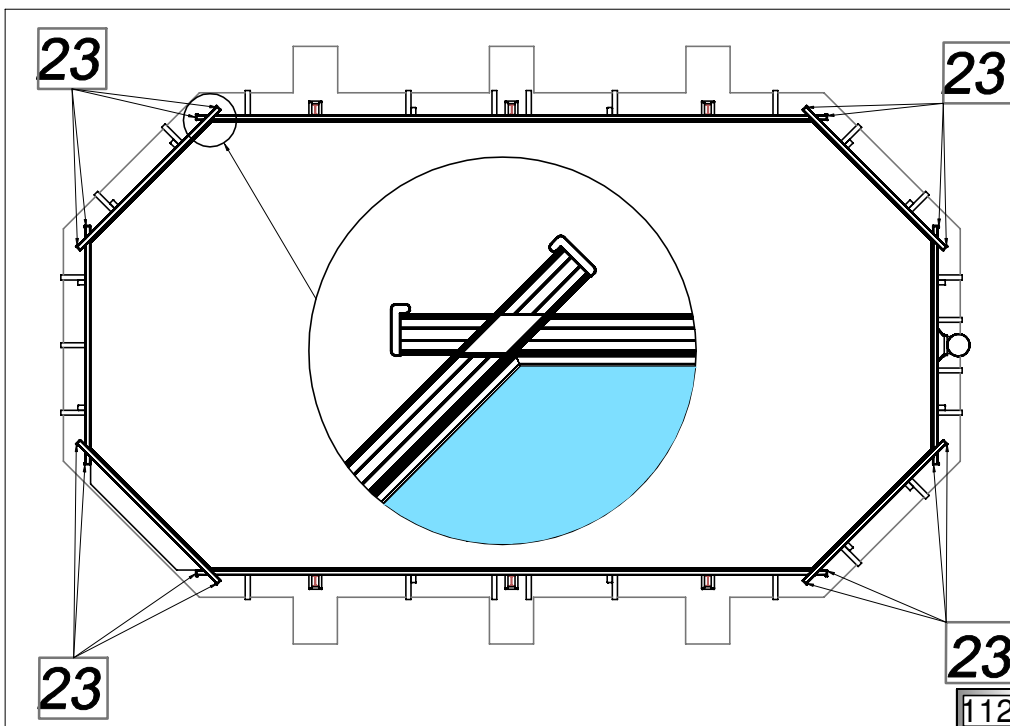
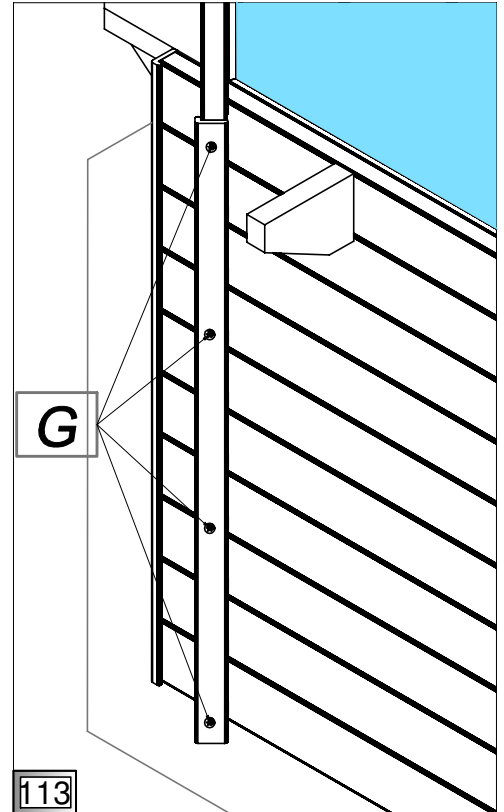
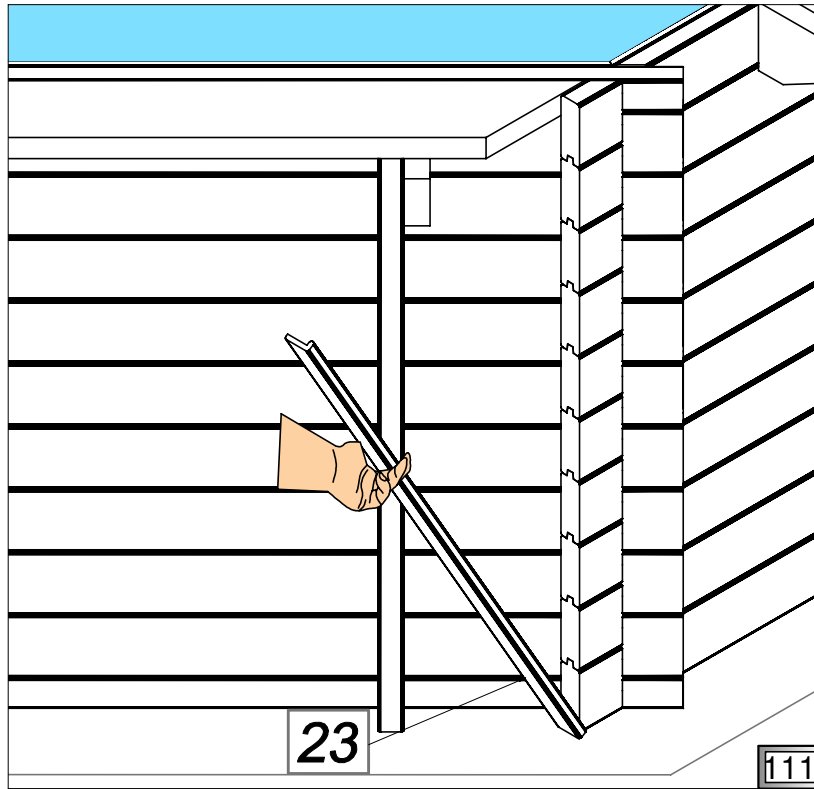
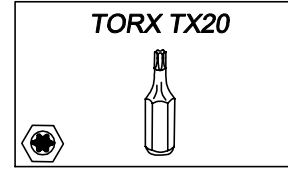
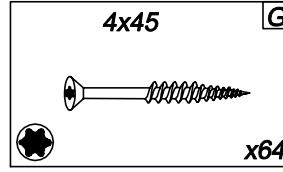
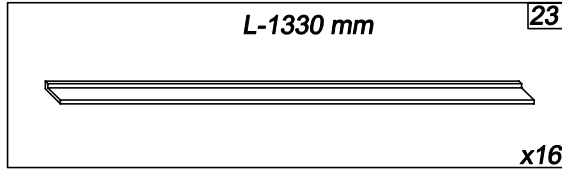

PL Taras

GB Terrace

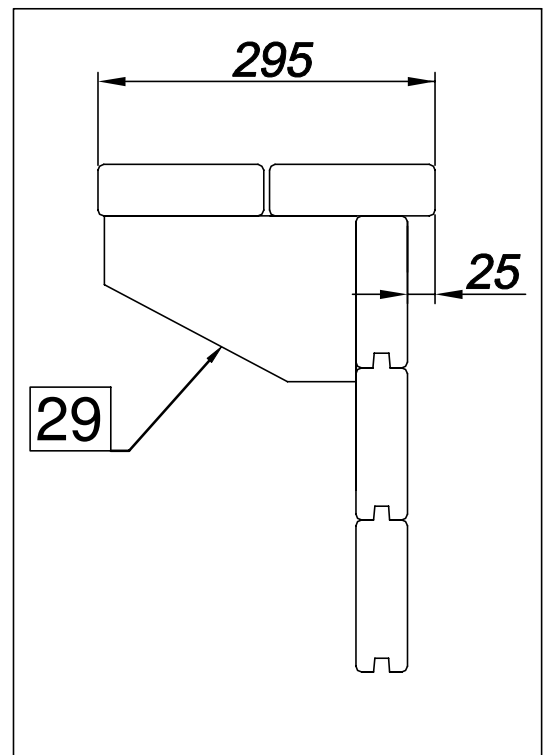
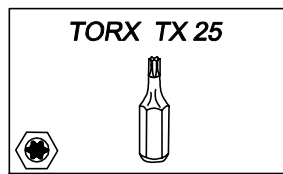
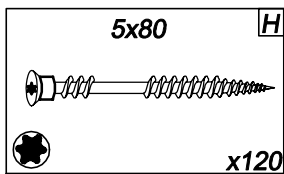
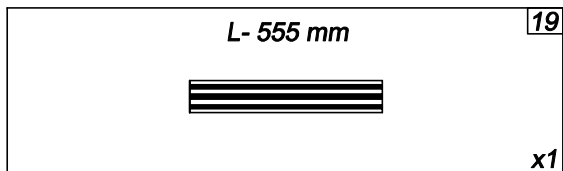
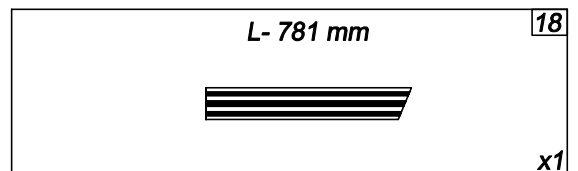
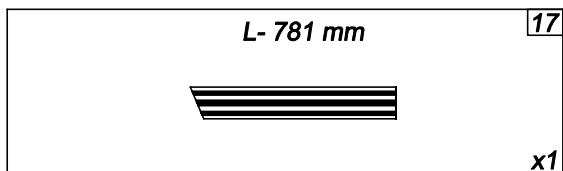
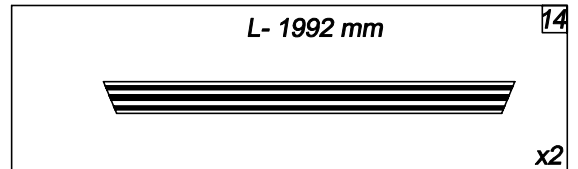
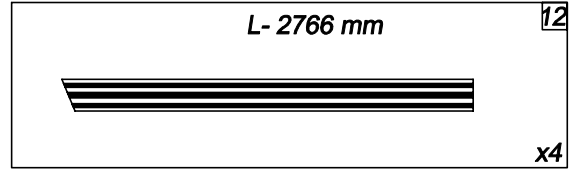
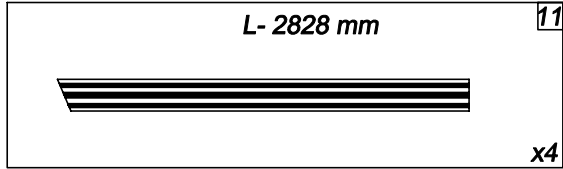

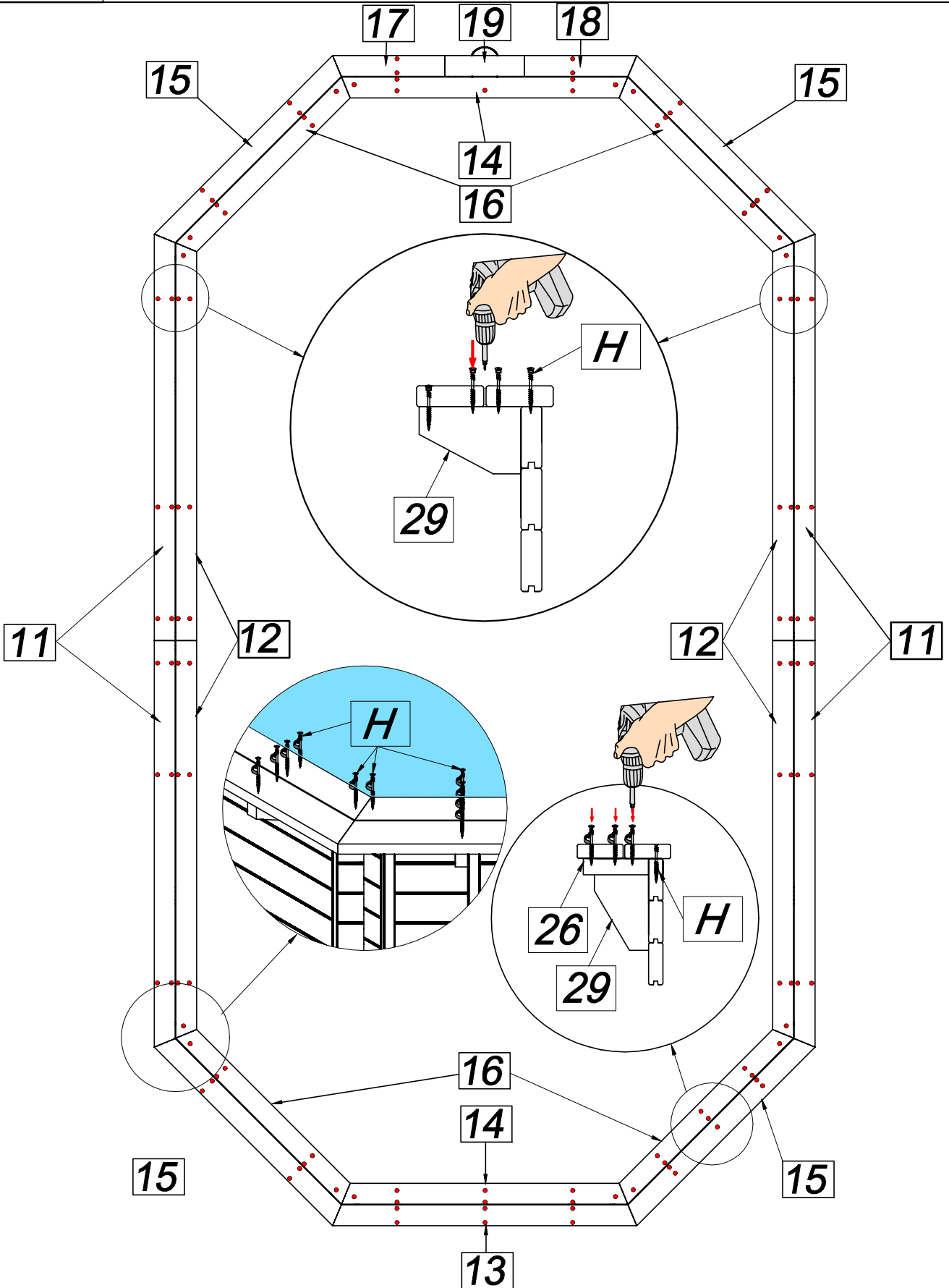

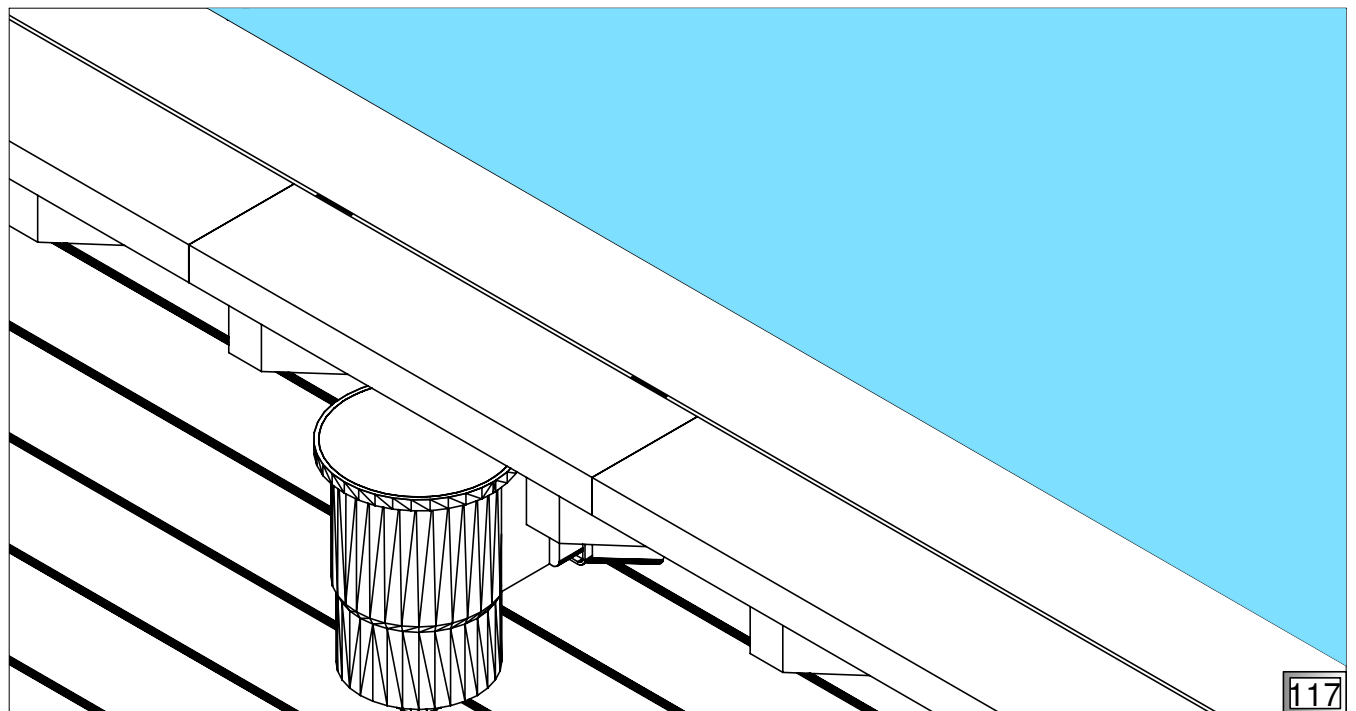
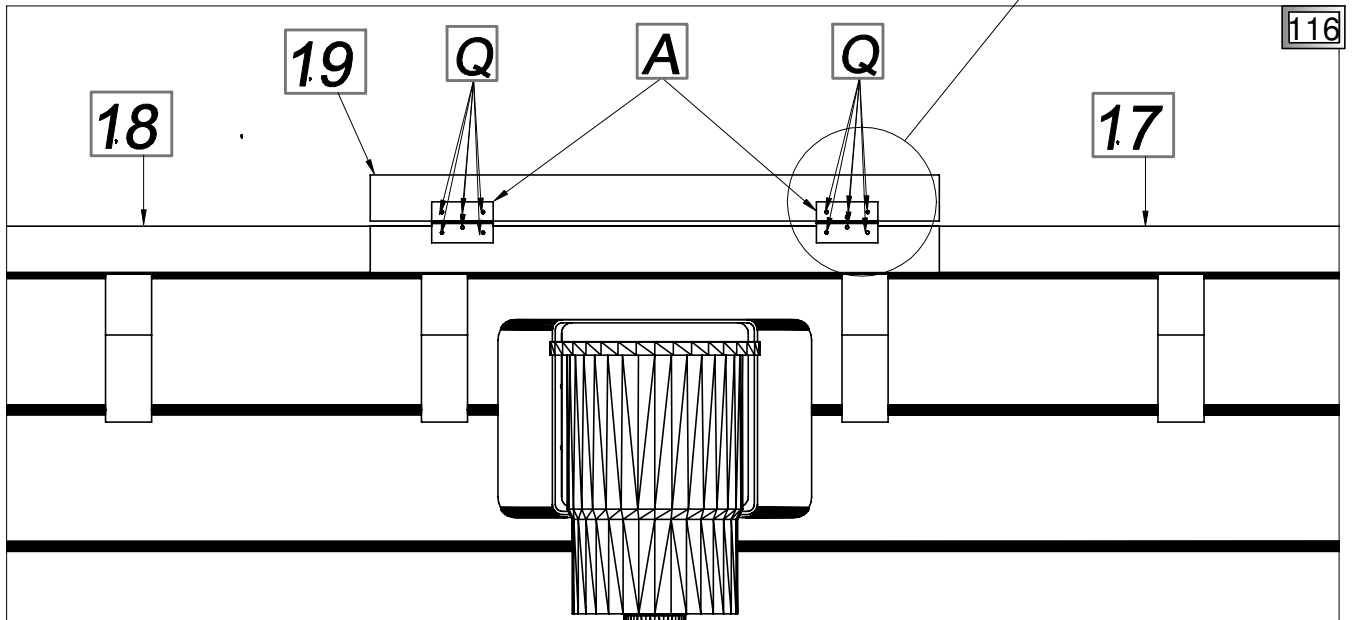
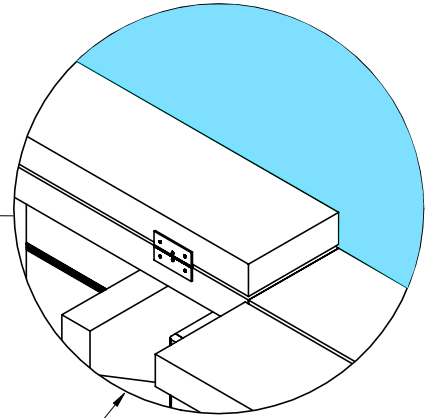
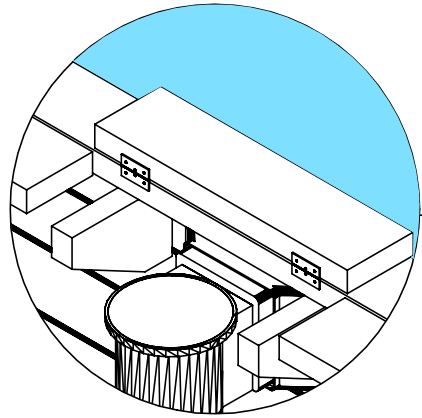
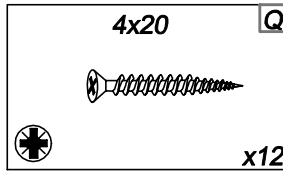
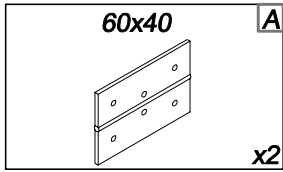

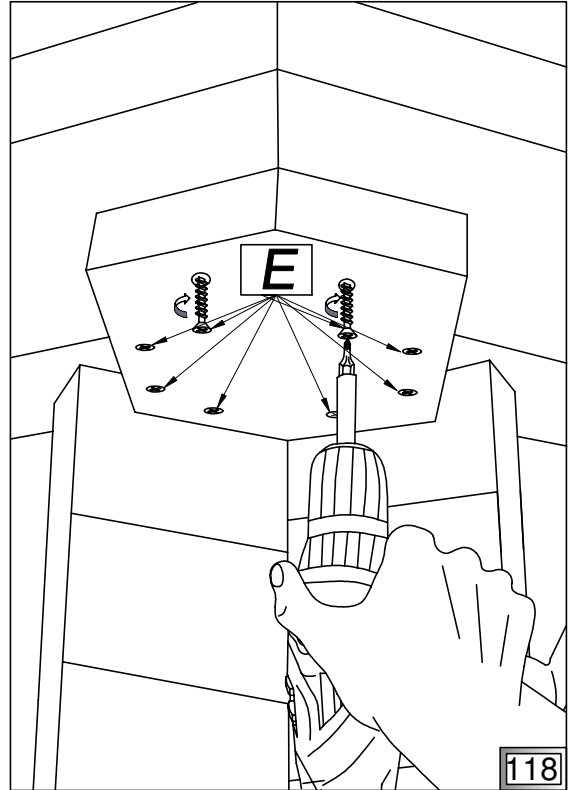
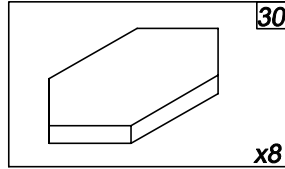
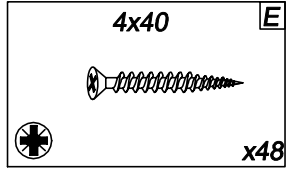

PL Widok od spodu tarasu.

GB View from the bottom of terrace.

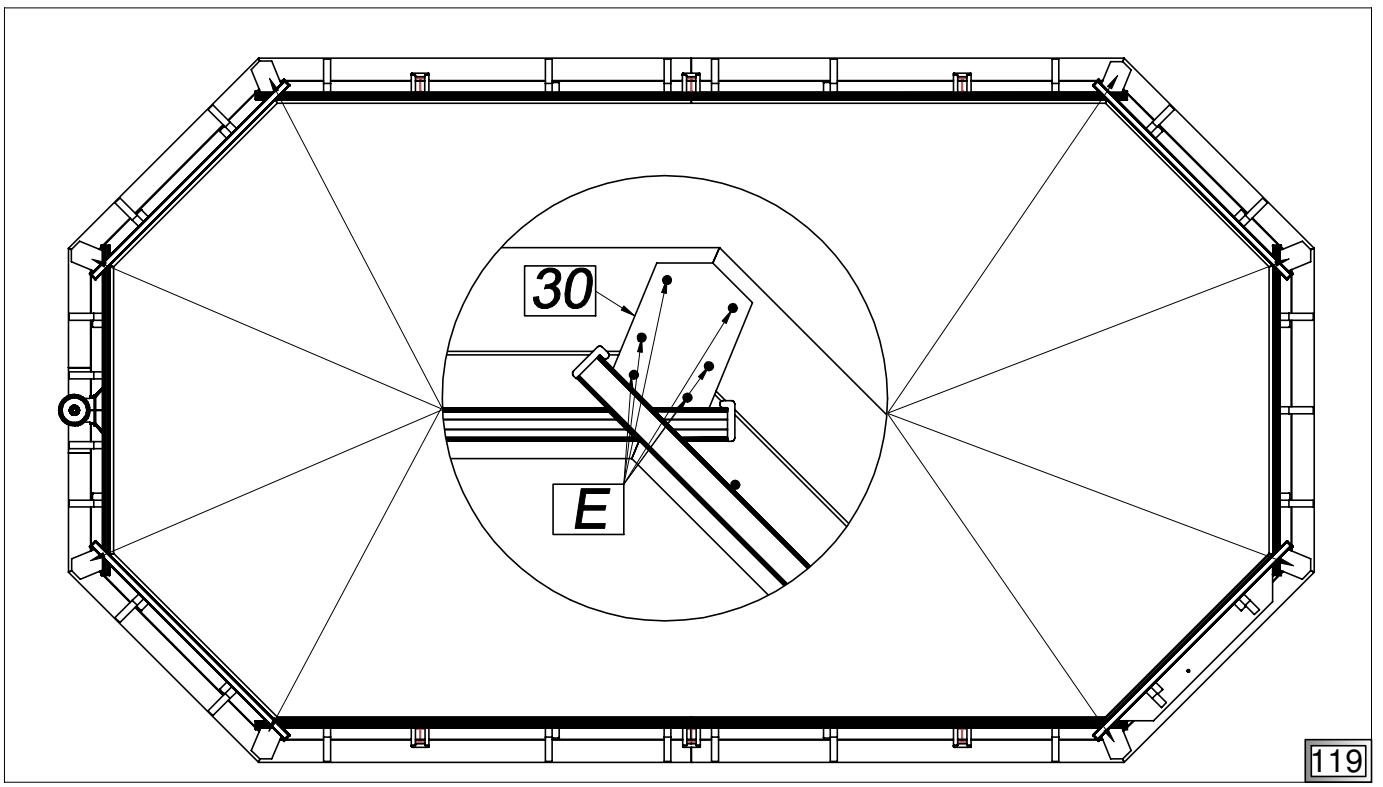

PL Schody drewniane

GB Wooden stairs

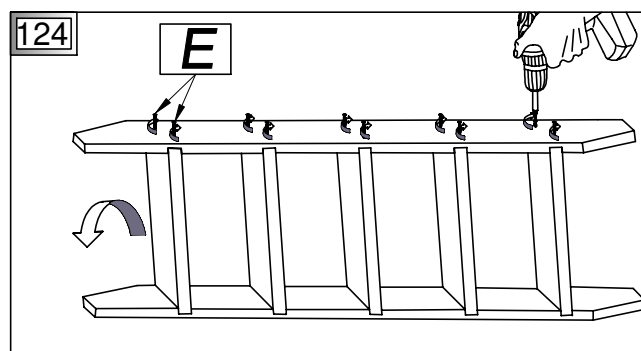
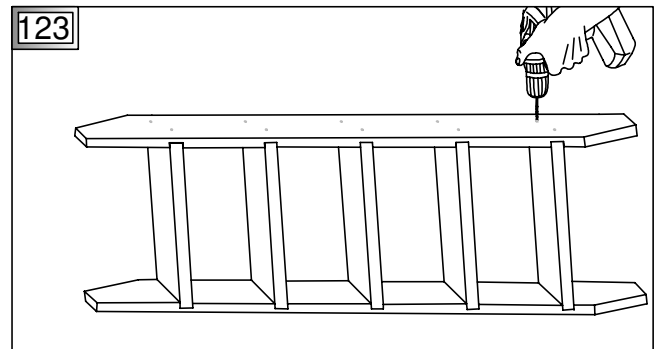
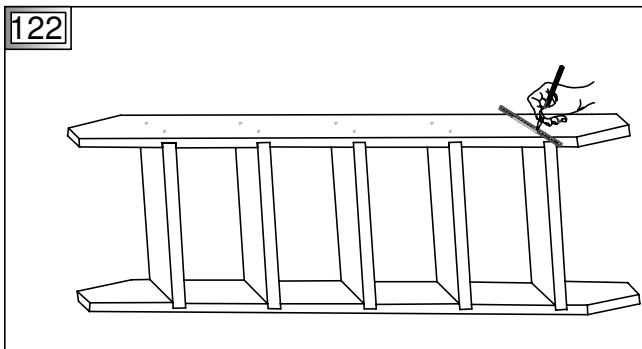
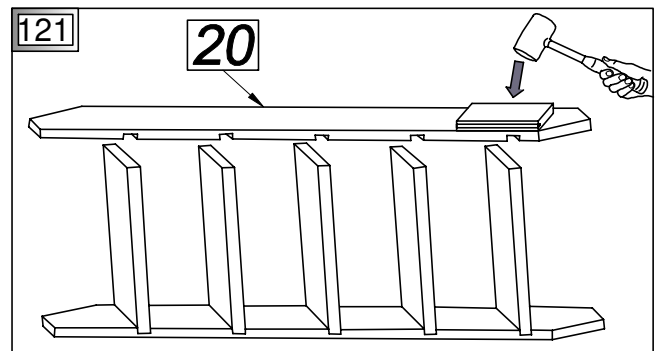
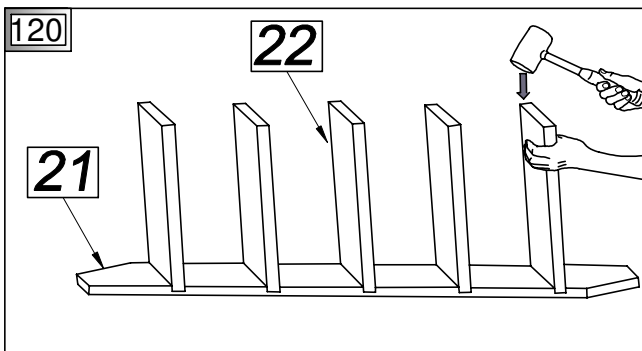
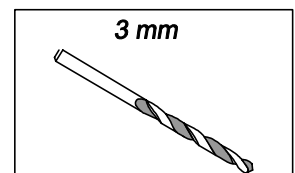
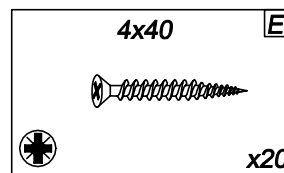
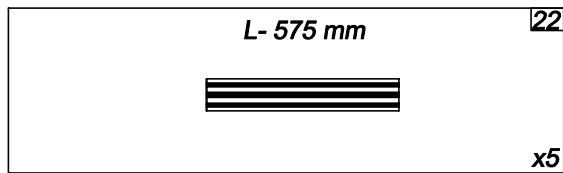
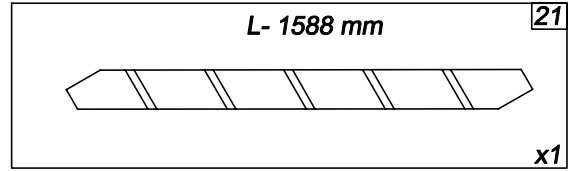
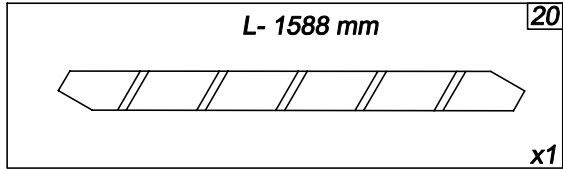

PL Schody drewniane

GB Wooden stairs

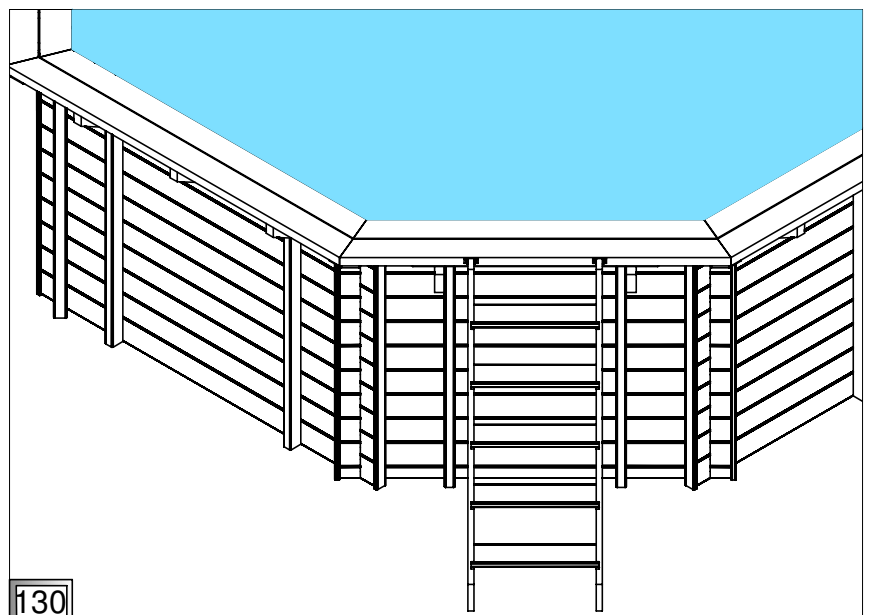
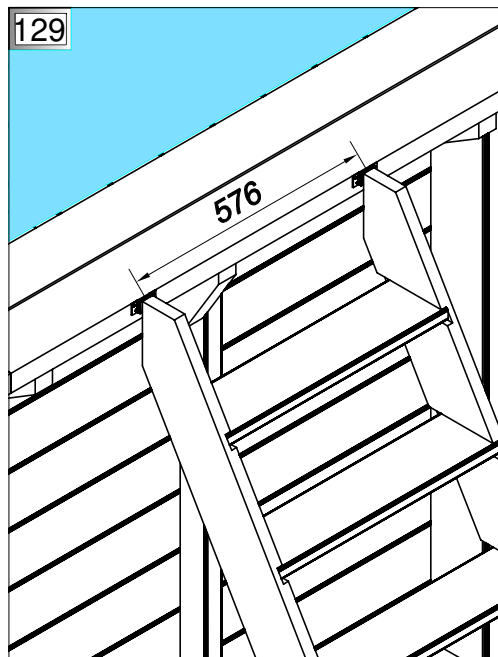
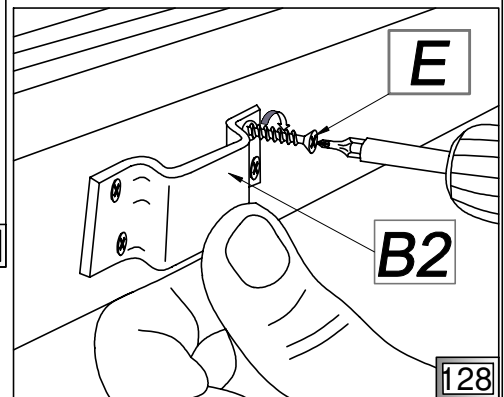
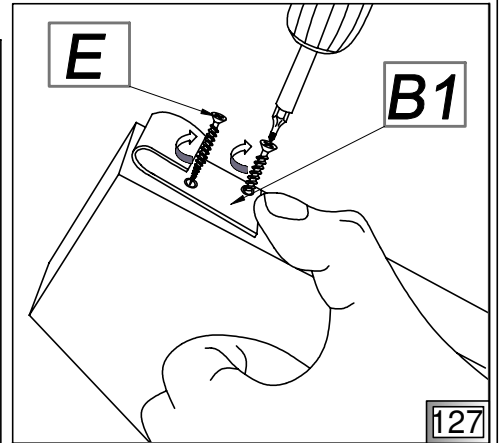
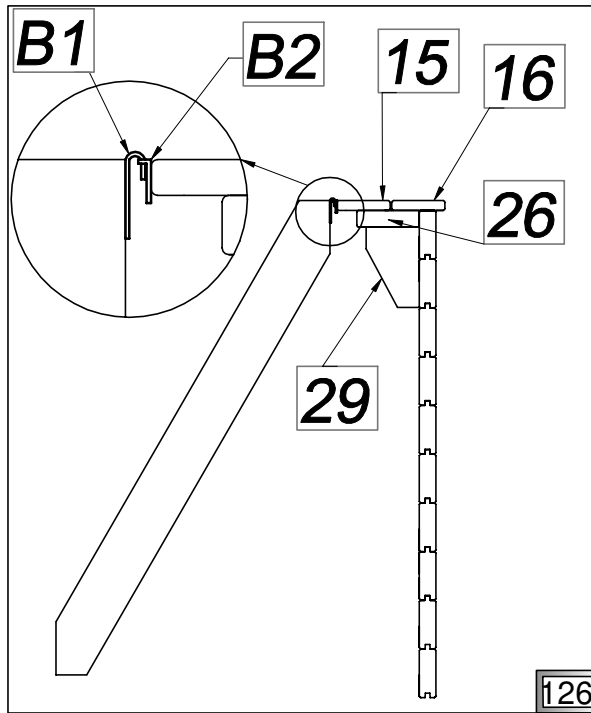
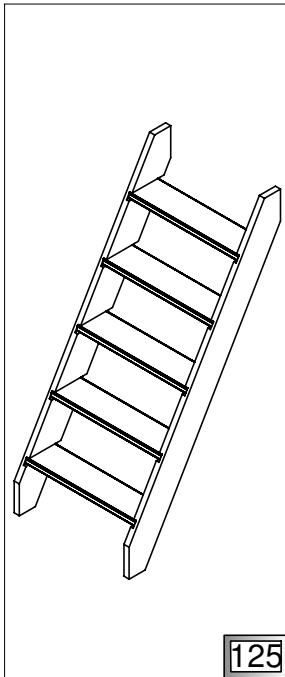
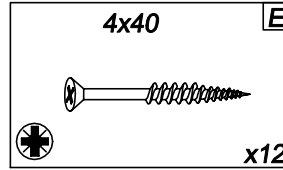
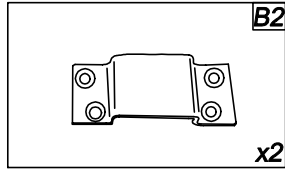
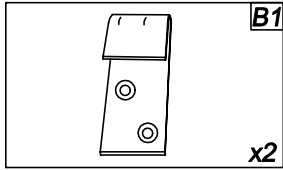

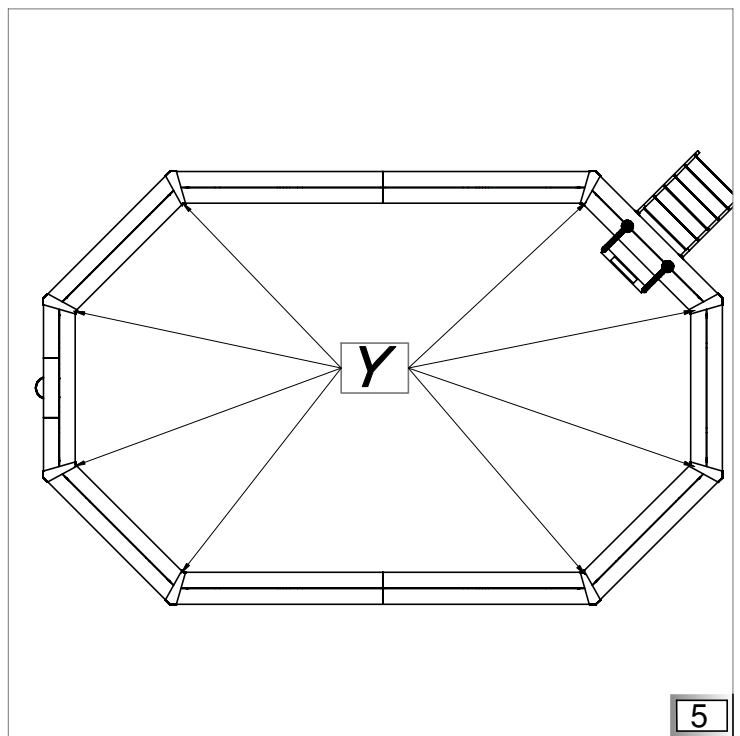
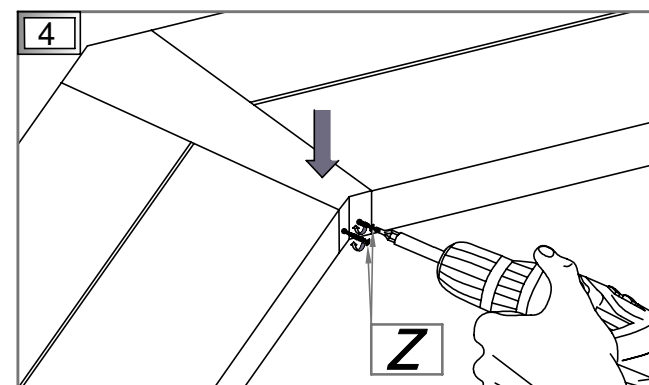
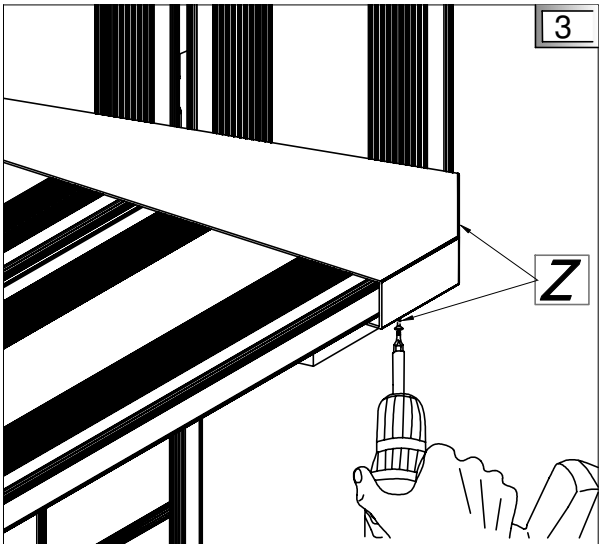
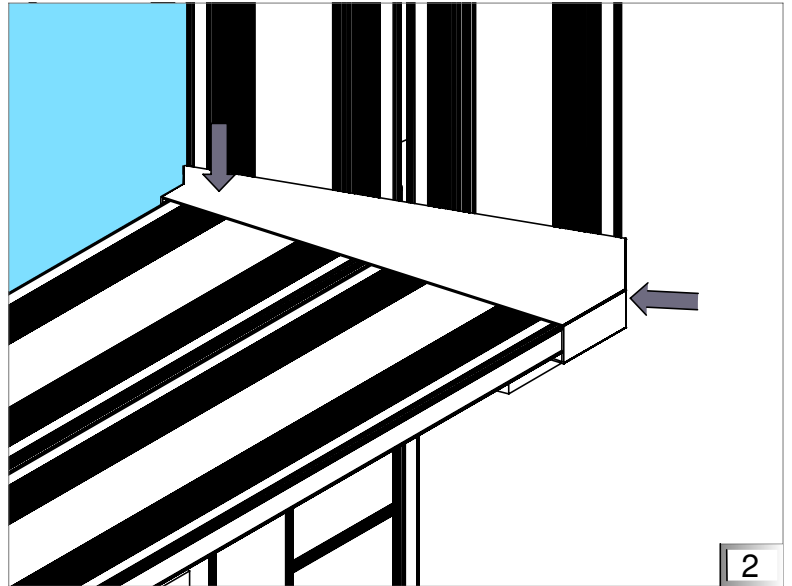
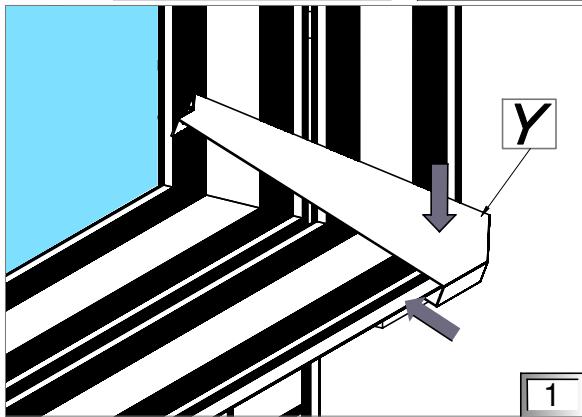
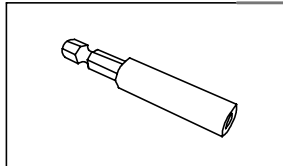
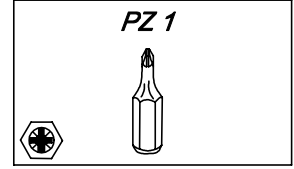
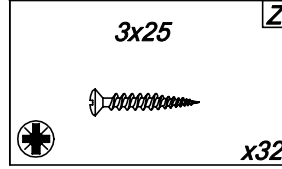
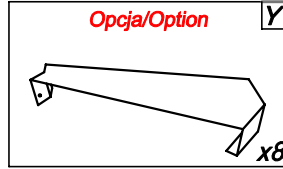
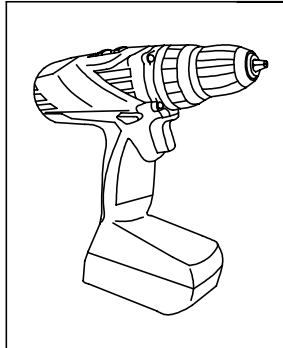

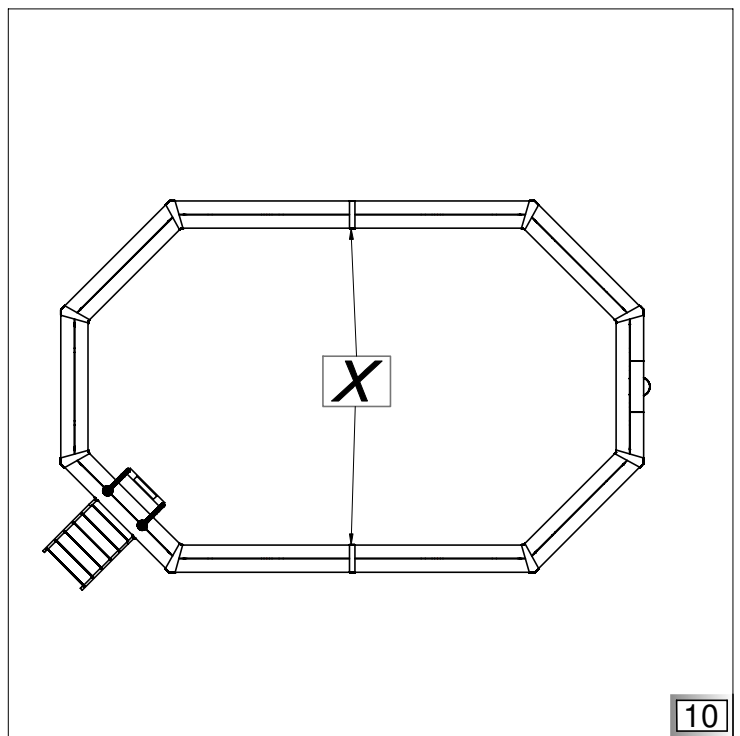
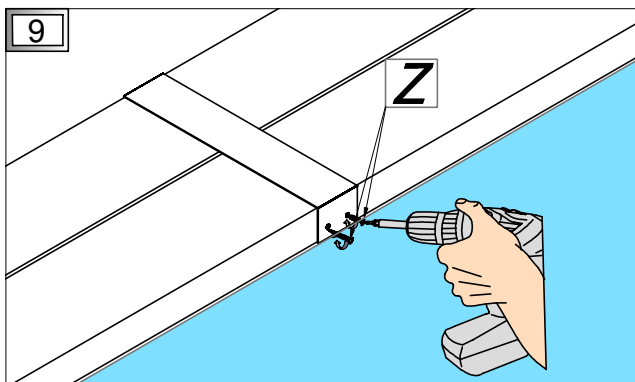
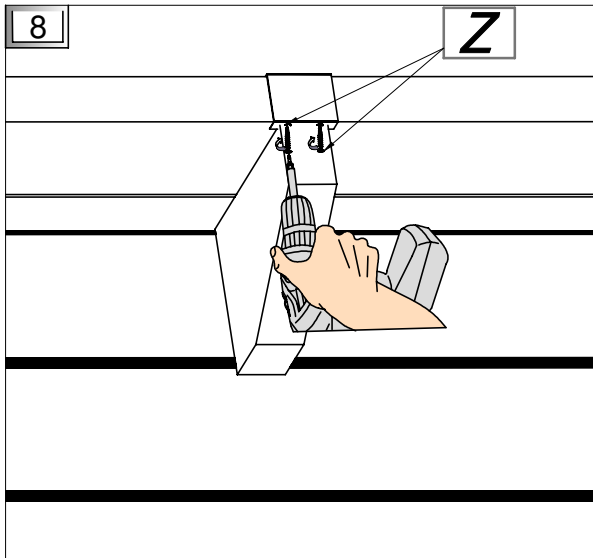
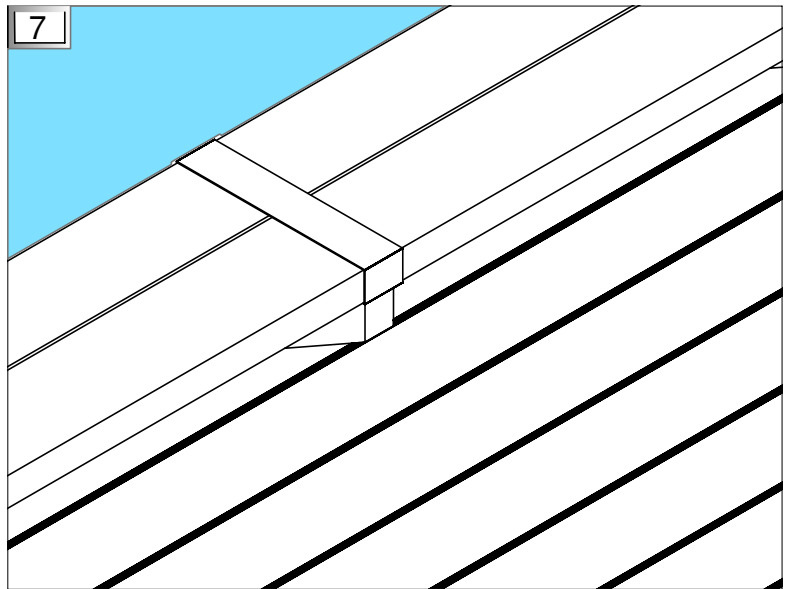
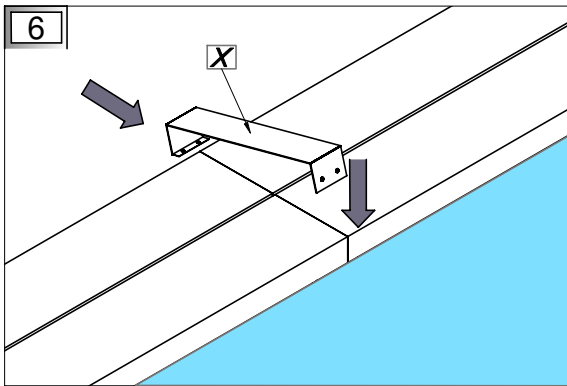
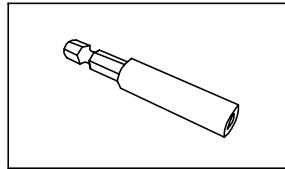
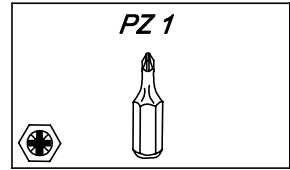
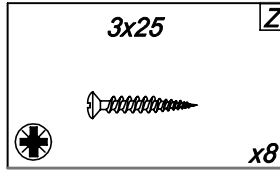
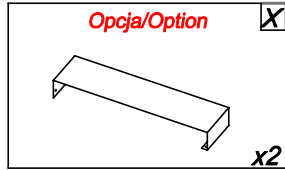
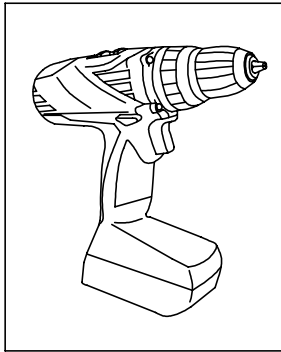

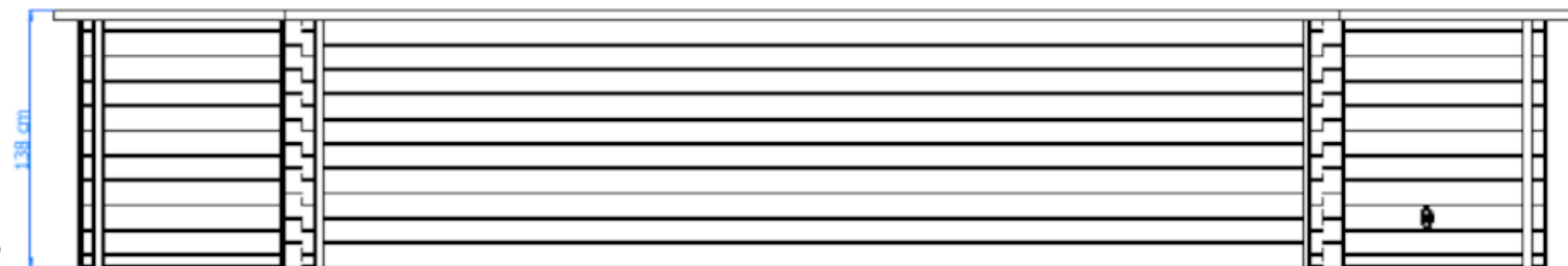
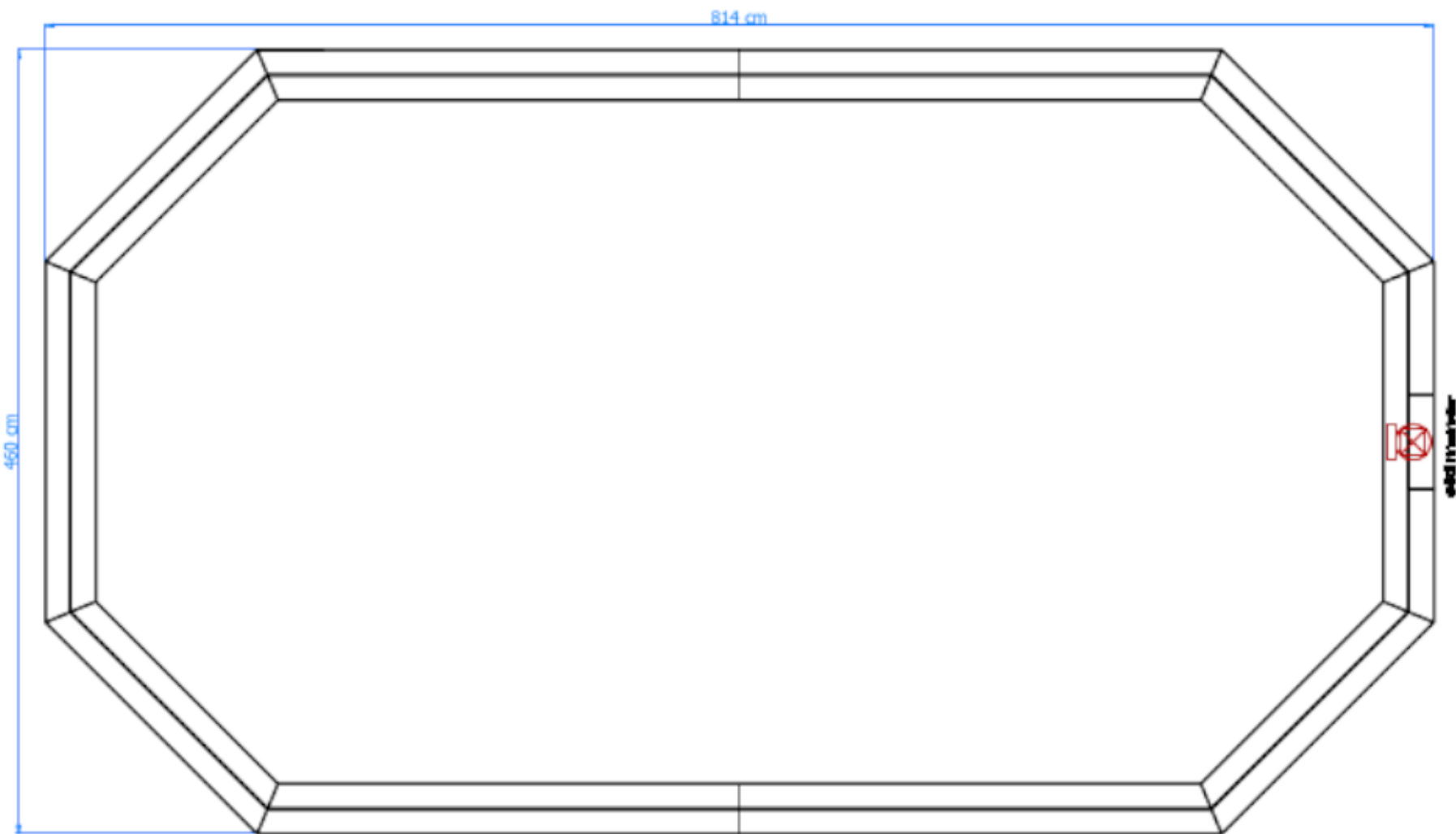

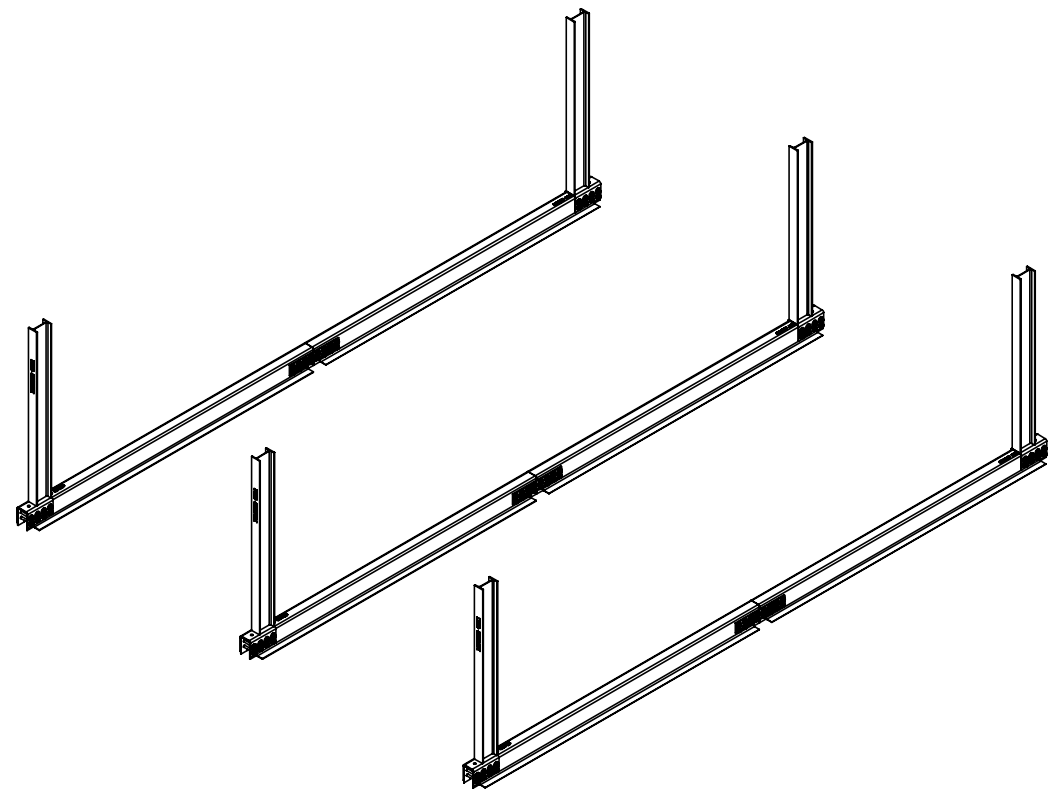
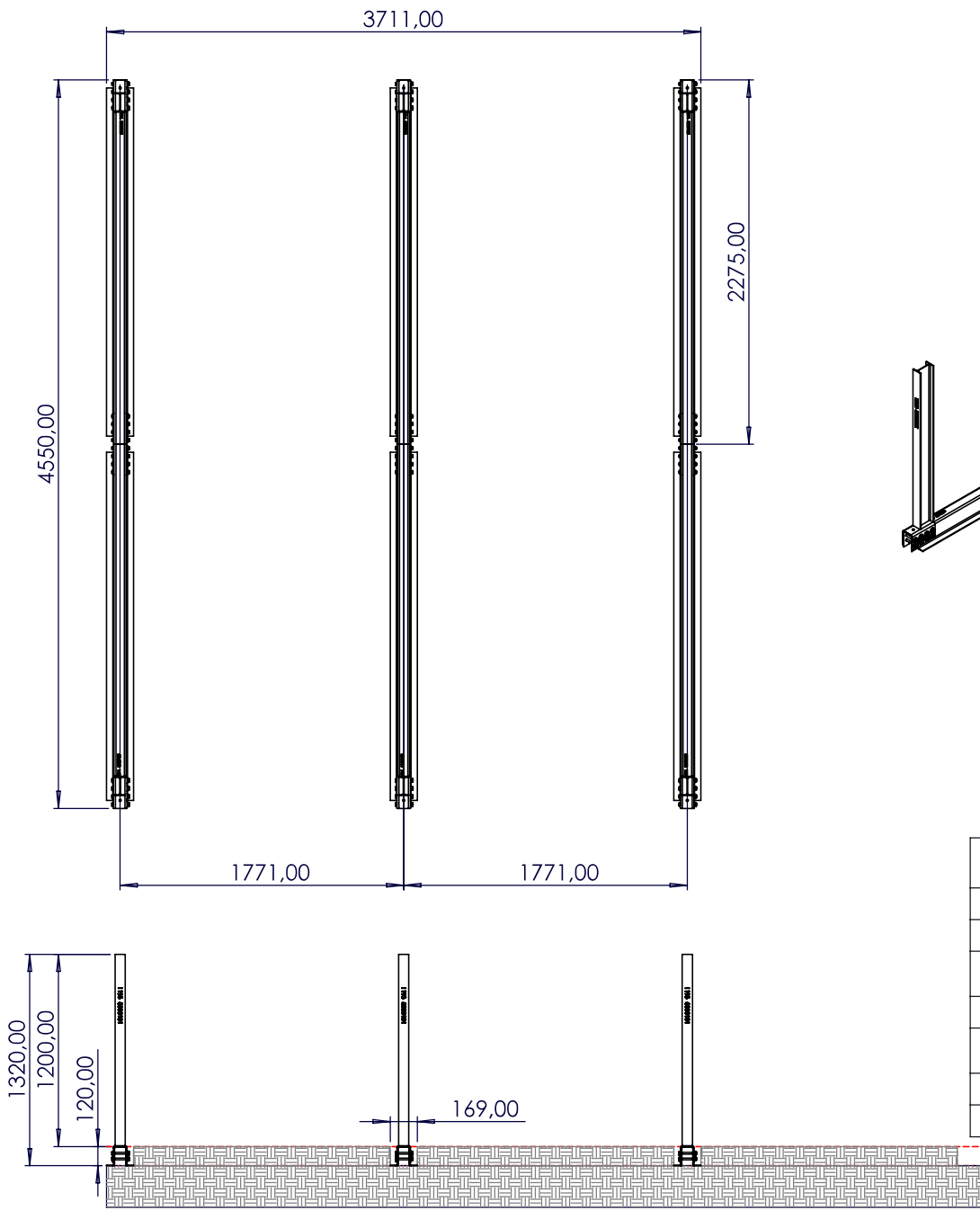

NUM. ARTICOLO	NUM. PARTE	COD ART	QUANTITÀ
1	INT_0050_03C_OMEGA_814	8030135	6
2	INT_0022_13_PIASTRA_LINEARE_V01	4030039	6
3	B18.2.3.5M - HEX BOLT M12 X 1.75 X 100 --100N		96
4	B18.2.2M - PLAIN WASHER, 12 mm, REGULAR		96
5	B18.2.4.1M - HEX NUT, STYLE 1, M12 X 1.75 --D-N		96
6	INT_0050_02B_IPE_120_1200	8030101	6
7	INT_0022_09_PROFILU_U_V04	4030030	6

CODICE ARTICOLO 8030139

KIT AUTOPORTANTE 814

13/02/2020
 Rev. 00
 foglio 1 di 2
 scala 1:30
 dis. n° 05

Il presente disegno non può essere riprodotto, copiato, modificato o comunicato ai terzi senza autorizzazione scritta.

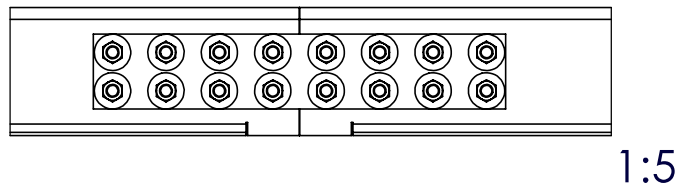
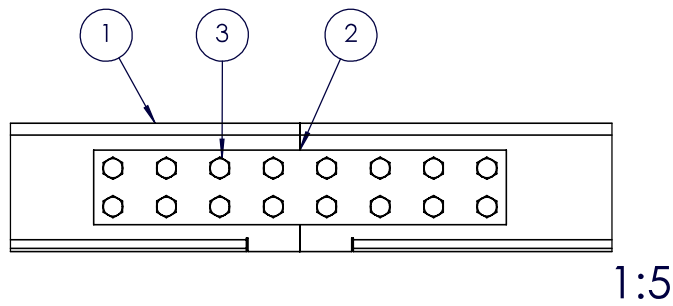
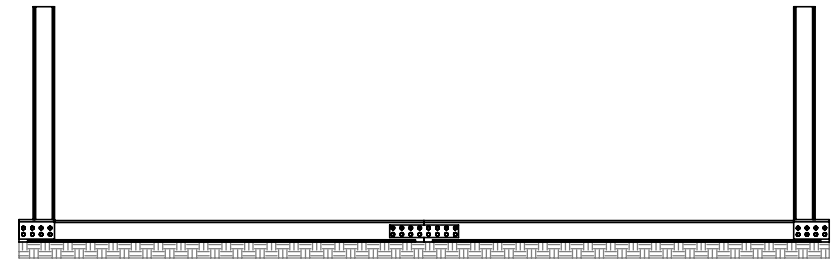
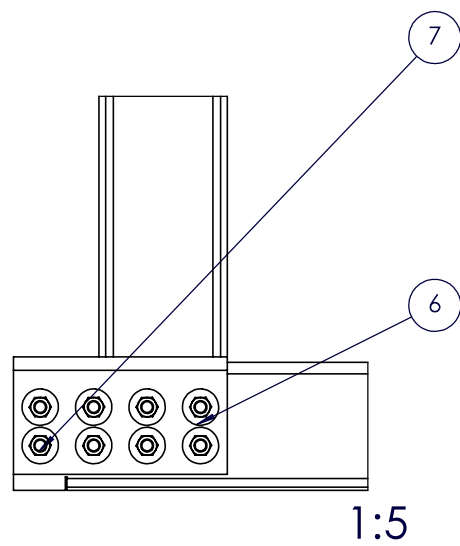
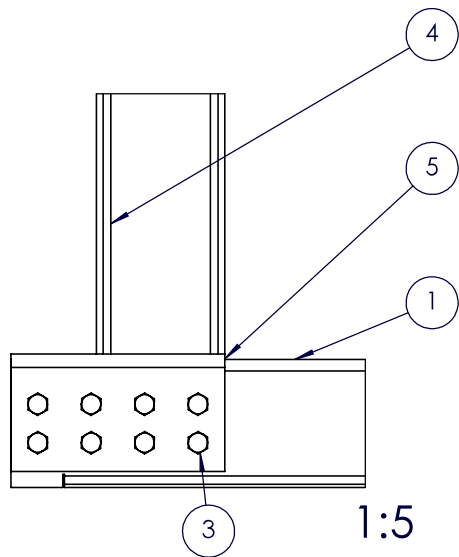

NUM. ARTICOLO	NUM. PARTE	COD ART	QUANTITÀ
1	INT_0050_03C_OMEGA_814	8030135	6
2	INT_0022_13_PIASTRA_LINEARE_V01	4030039	6
3	B18.2.3.5M - HEX BOLT M12 X 1.75 X 100 --100N		96
4	B18.22M - PLAIN WASHER, 12 mm, REGULAR		96
5	B18.2.4.1M - HEX NUT, STYLE 1, M12 X 1.75 --D-N		96
6	INT_0050_02B_IPE_120_1200	8030101	6
7	INT_0022_09_PROFILU_U_V04	4030030	6

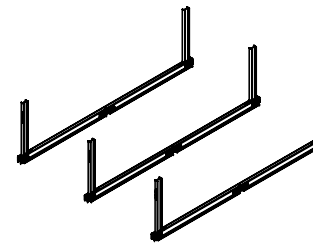

CODICE ARTICOLO 8030139

KIT AUTOPORTANTE 814

13/02/2020
Rev.
00
foglio
2 di 2
scala
1:30
dis. n°

06